

Operation Manual

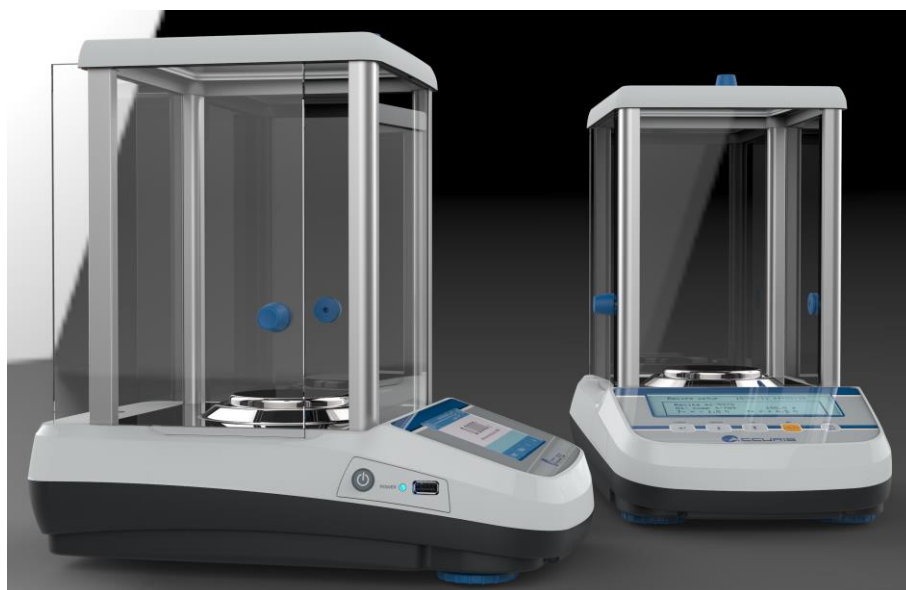

Analytical Balance Series Tx Models W3002A-120 / W3102A-220 (Touch Screen)



Revision 1-18

INDEX

| | | |
|----------|---|-------------------------------------|
| 1 | SAFETY INSTRUCTIONS AND WARNINGS | 3 |
| 2 | STORAGE CONDITIONS | 3 |
| 3 | PREPARING TO START UP THE DEVICE | 4 |
| 3.1 | UNPACKING / PACKING | 4 |
| 3.2 | OVERVIEW AND ACCESSORIES INSTALLATION | 7 |
| 3.3 | INSTALLATION PLACE | 8 |
| 3.4 | START-UP | 9 |
| | SIDE KEYBOARD OPERATION | ERROR! BOOKMARK NOT DEFINED. |
| 3.5 | DESCRIPTION..... | ERROR! BOOKMARK NOT DEFINED. |
| 4 | SERIAL INTERFACE CONNECTIONS | 10 |
| 4.1 | DISPLAY AREA OPERATION | 11 |
| 4.1.1 | <i>Operating instructions of the numeric and alphanumeric keypads for entering data</i> | 13 |
| 5 | STANDBY, LOGOUT, SWITCHING OFF FUNCTIONS | 15 |
| 6 | SIMPLE WEIGHING | 16 |
| 7 | CUSTOMIZED SETTINGS | 18 |
| 7.1 | SELECTING THE LANGUAGE | 19 |
| 7.2 | SETTING DATE AND TIME | 20 |
| 7.3 | CREATING, CHANGING AND SELECTING THE USER PROFILE | 21 |
| 7.3.1 | <i>Recovering and removing passwords</i> | 26 |
| 7.4 | PREFERENCES: LANGUAGE, DISPLAY APPEARANCE, BRIGHTNESS, BEEPER, FUNCTIONS | 27 |
| 7.5 | SETTING THE WEIGHING PARAMETERS..... | 29 |
| 7.6 | SELECTING THE UNIT OF MEASUREMENT | 30 |
| 7.7 | SELECTING THE CUSTOM MEASUREMENT UNITS | 31 |
| 7.8 | CALIBRATING AND SETTING THE CALIBRATION MODE | 32 |
| 7.9 | SETTING THE PERIPHERALS | 35 |
| 7.10 | INFO ABOUT THE SOFTWARE | 39 |
| 7.11 | SERVICE | 39 |
| 7.11.1 | <i>System data backup and restore</i> | 39 |
| 7.11.2 | <i>Factory reset</i> | 41 |
| 7.11.3 | <i>Software update</i> | 42 |
| 7.11.4 | <i>Balance technical service</i> | 42 |
| 8 | FUNCTIONS MENU | 43 |
| 8.1 | USING THE DATABASE | 44 |
| 8.2 | FUNCTION FOR COUNTING THE PIECES | 45 |
| 8.2.1 | <i>Pieces count screen with “Statistics” function</i> | 47 |
| 8.2.2 | <i>Pieces count screen with “Check weight” function</i> | 48 |
| 8.3 | “CHECK WEIGHT” FUNCTION..... | 49 |
| 8.3.1 | <i>“Check weight” screen function</i> | 50 |
| 8.4 | “WEIGHT %” FUNCTION..... | 51 |
| 8.4.1 | <i>Screen of Weight % with “Statistics” function</i> | 53 |
| 8.4.2 | <i>Screen of Weight % with “Check weight” function</i> | 54 |
| 8.5 | FUNCTION TO “FIX THE DENSITY” | 55 |
| 8.5.1 | <i>Screen with the “Density of a solid” calculation function</i> | 57 |
| 8.5.2 | <i>Screen with the “Density of a liquid” calculation function</i> | 57 |
| 8.5.3 | <i>Screen with the “Density index” calculation function</i> | 58 |

| | | |
|-----------|---|-----------|
| 8.6 | “STATISTICS” FUNCTION | 59 |
| 8.6.1 | Screen with “Simple statistics” function..... | 60 |
| 8.6.2 | Screen with “Database statistics” function..... | 61 |
| 8.7 | “TEXTILE” FUNCTION..... | 63 |
| 8.7.1 | Screen of the “Textile” function..... | 64 |
| 8.7.2 | Screen of the database textile function with statistics enabled | 65 |
| 8.8 | “ANIMAL WEIGHTING” FUNCTION | 67 |
| 8.8.1 | Screen of the “Animal weighting” function..... | 68 |
| 8.9 | “MAXIMUM LOAD” FUNCTION | 69 |
| 8.10 | “RECIPE” FUNCTION..... | 70 |
| 8.10.1 | Screen of the “Simple recipe” function..... | 73 |
| 8.10.2 | Screen of the “Database recipe” function..... | 74 |
| 8.11 | SETTING THE GLP DATA..... | 76 |
| 9 | TECHNICAL FEATURES..... | 78 |
| 10 | WARRANTY..... | 79 |
| 11 | DISPOSAL..... | 79 |

1 Safety instructions and warnings



CAUTION!

Please read these instructions for installation and operation carefully before starting your work with the new balance. Keep this instruction manual for future reference.

This balance complies with the directives and standards for electrical equipment, electromagnetic compatibility and date safety requirements.

If the installation is not performed in accordance with the instructions given or is improperly used, the warranty can be void.

- Do not use the device in areas at risk of explosion.



- Before starting the device for the first time, check if the power supply unit or the power cord is damaged and confirm that the voltage of the wall outlet to be used corresponds to the mains voltage required.

2 Storage conditions

- **Storage temperature:** +5 °C...+40°C
- **Storage humidity:** 45% - 75%.
- **Keep the original balance packaging** in case the instrument needs to be shipped for servicing; disconnect all cables and any accessories to prevent unnecessary damage.
- **Do not expose** the balance to extreme temperatures and humidity unnecessarily, and avoid violent shocks and vibration.

3 Preparing to start up the device

Below are all preparation steps to follow before initial use.

3.1 Unpacking / packing

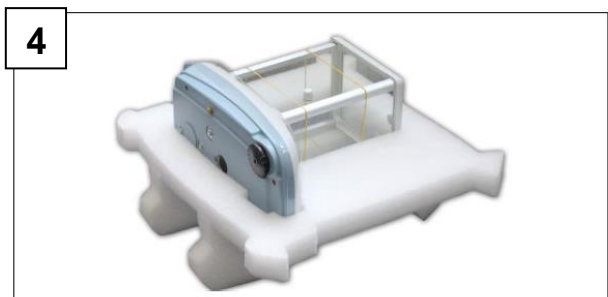
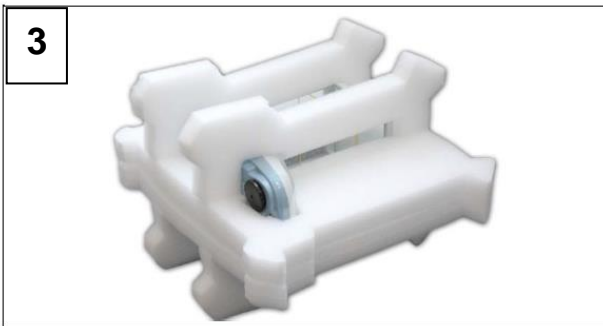

- After opening the box from the top, you can find the accessory box containing: User's Manual, Weigh Pan, Weigh Pan Support; Anti-draft ring, Power supply unit, Power supply box. Remove the accessory box and then carefully lift the balance with the protective foam parts in place.

- **IMPORTANT:** Keep the original balance packaging in case the instrument needs to be shipped for servicing; disconnect all cables, remove weigh pan and pan support, place rubber band around draft shield or tape the glass doors closed, and separate and package accessories to prevent unnecessary damage.

Always use the original packaging for shipping the instrument to an authorized Service Center to prevent damage. Below are the procedures.

- Before packing, remove the weight pan, pan support, draft ring, and any other loose parts, and place them in the accessory box.

- Following the below steps to pack again the balance in its box:

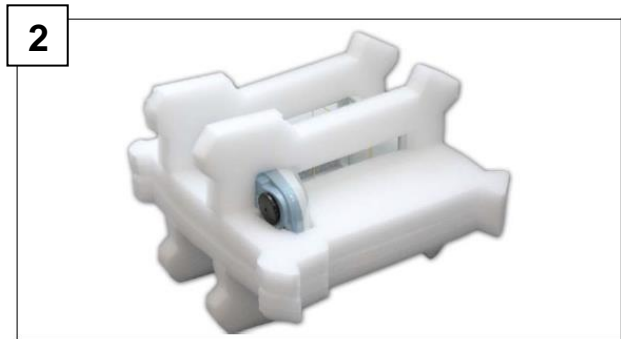
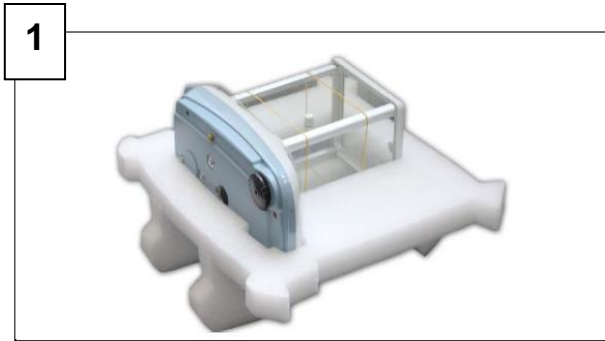

3.2 Overview and accessories installation

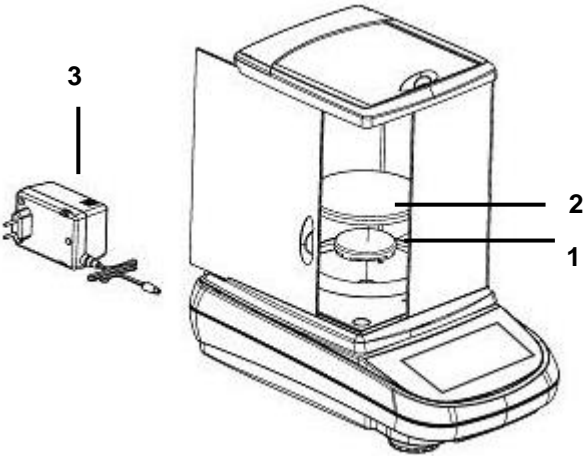

1 – Pan Support

2 – Weigh Pan

3 – Power supply unit

3.3 Installation

- **After removing** the balance and accessories from the packaging, check for visible damage to the device.
- **Do not install** the balance in any room or location where there are any air currents, strong heat shifts, or vibrations.
- **Do not use** the balance in explosive atmospheres.
- **The ambient humidity** of the environment should be between 45% and 75%.

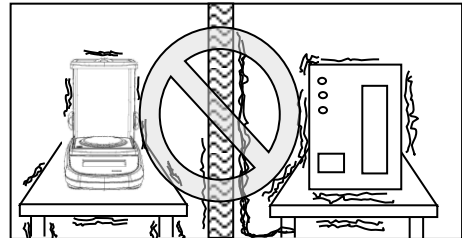
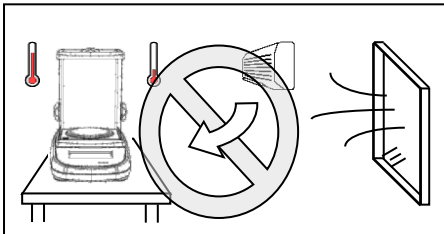

3.4 Start-up

For internal calibration **Analytical balance models**, manually remove the shipping screw at the bottom of the left-hand balance. Note: **Semi Micro** (0.01mg readability) do not use this shipping screw.



CAUTION!



Level the balance by adjusting the legs on the front of the balance. Some models also have an adjustable leg on the rear left.

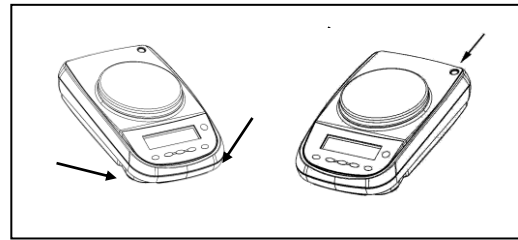
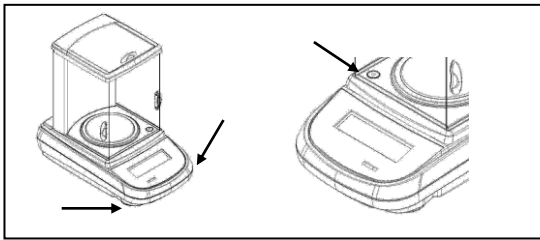

It is important to allow the balance to equilibrate to the ambient environment after powering on, and before using. For 0.0001g balances, allow the balance to equilibrate for 2 hours. For 0.01mg balances, allow the balance to equilibrate for 12 hours. For calibration procedures, please refer to the "**Device calibration chapter**". Perform the device calibration whenever it is moved to another place.

Never drop objects onto the the balance weigh pan, and never place objects on the pan that weight more than the maximum capacity for the balance.

Any service must be performed by trained personnel and the spare parts used must be original. To arrange service, contact your distributor or Accuris Instruments.



Insert the supplied power supply unit jack into the connector on the back of the balance.



Then **connect** the power adapter to an appropriate power outlet near the device. Do not use cables/extensions that do not comply with applicable regulations.

Powering On

The power button is located on the front control panel to the left of the touch screen.



After connecting the power supply unit, the device will start automatically without having to press the power button.

Use the power button to turn off the device and restart the system when the power cord is already plugged in.

The turn-on and shut-down time of the device takes about 20 seconds, during this time the display will be turned off.

When powering on, wait for the initial screen to appear before performing any other operations.

When switching off, wait for the green LED to turn off before removing the power supply socket, if necessary.

4 Serial interface connections

The device is equipped with an RS 232C interface for connection to a serial printer.

To ensure communication between the device and a printer, the following conditions must be met:

Connect the printer using a suitable cable matching the position of the printer signals with the device ones.

Set the transmission speed and type of printer correctly according to the parameters of the printer. See Chapter 7.7

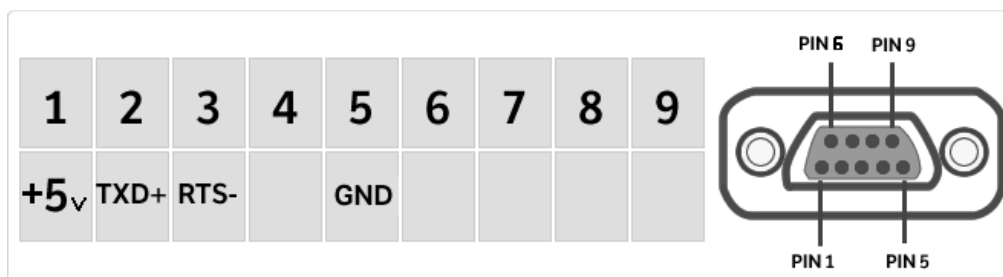

It is recommended that you use the Accuris Balance printer W3130 (DPP-250) from Benchmark Scientific. (If you are using different printers, not all printing capabilities will be available).

4.1 Touch Screen Operation

The balance incorporates a color touch screen display that lets you touch the screen in active areas to quickly access the various menus and features of the device.



1 Weighing value display

g Measuring unit indication, by tapping the symbol, you can access the measurement unit menu and select the desired unit.

***** Stability indicator.

T Man Indication of weight displayed. **Net** net value, **Ldr** gross value

T = Tare value indicator.

 Analog indicator bar of magnitude being measured.

Max 6200g d=0.01g Technical Specifications for the instrument

2 Menu Bar displaying the date, time, for user selection, access to weighing functions, weighing and device shutdown parameters setting.

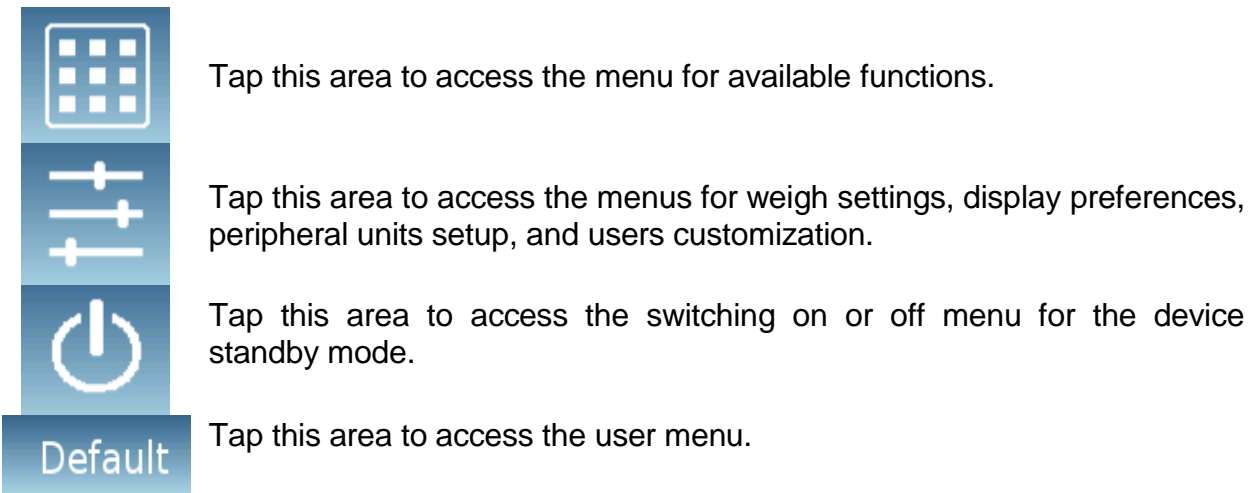

3 Function key menu bar.

Touching the keys displayed in this area, you will run the corresponding function. Below are all the keys available in the simple weighing screen. The function key display bar varies according to the selected applications.



Key bars available in simple weighing screens.



Print: Data printing activation key.

- 0-: Reset activation key.

-T-: Tare operation activation key.

Gro/Net: Net or gross weight display mode key.

T Man: Key for entering a tare value manually.

4.1.1 Operating instructions of the numeric and alphanumeric keypads for entering data

The operation of the alphanumeric keyboard described below is valid for all data entry operations in the various operating modes of the device.

Mod 1



Alphanumeric keypad.



Selection key for entering uppercase or lower case letters



Delete key of the last entered character



Delete key for all entered characters



Back and forward cursor movement key on the inserted string



Key to confirm and store the entry



Keyboard character selection key. Tap this key to rotate the various characters available for entry:
Mod 1, Mod 2, Mod 3



Input operation cancellation key.

Mode 2

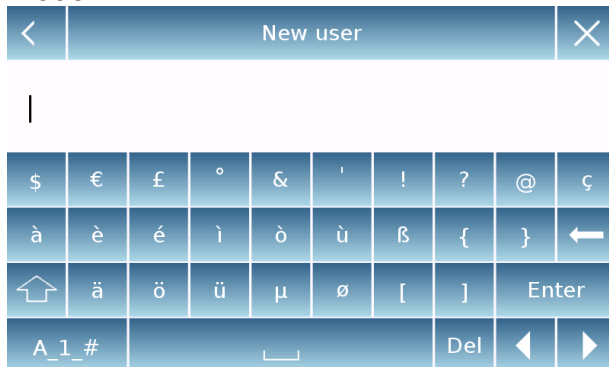

Mod 3

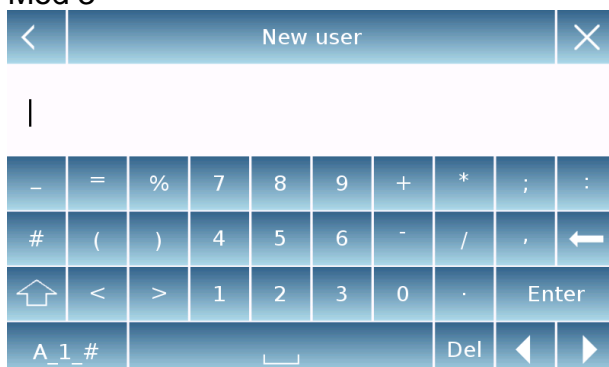

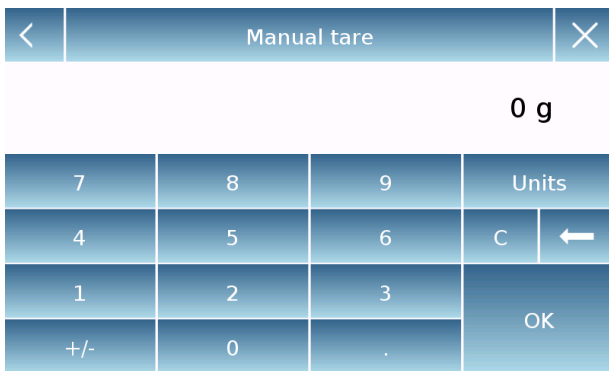

Numeric keypad.



Delete key of the last entered character



Key to confirm and store the entry



Delete key for all entered characters



Input operation cancellation key.



Key for selecting the unit of measurement.

5 Standby, logout, switching off functions

After inserting the power cord into the mains socket, the device will automatically turn on showing the basic weighing screen.

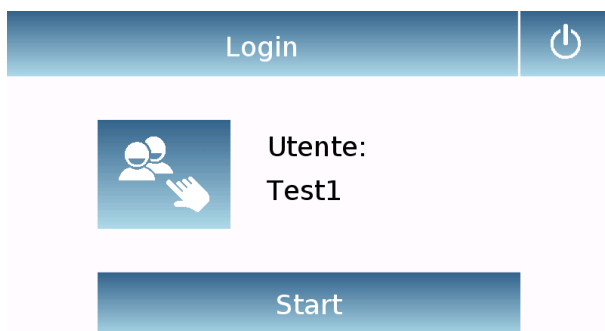
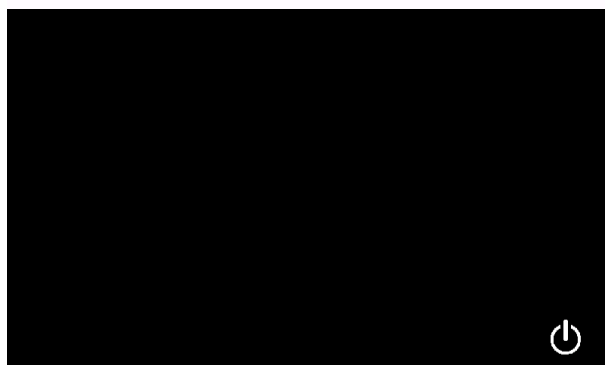
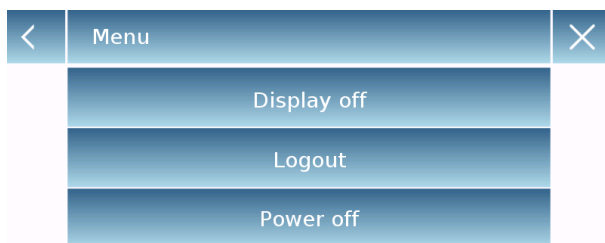

Tap the area with the symbol  to access the switching off menu.

There are 3 switching off modes:

- Display off.
- Logout.
- Switching off.

Display off

By selecting the display off mode, the device will enter in the standby mode, the display will be off and it will remain ON only the lower-right command to turn on the system again.

Touch the symbol to return to the basic weighing screen.

Logout

Select the logout mode to enable the user used.

Touch the key “**Start**” to enable again the user and, if the user is password-protected, you will be required to enter it.

Touching the key , you can select another user and start the device again.

Switching off

By selecting the power-off command, the device will be off. To restart, you will need to press the button on the left of the device or remove the power plug and reinsert it.

6 Simple weighing

After connecting the power, the green status LED on the left side of the device will light up. This phase will last about 20 seconds, and the display will remain off all the time. After the data loading phase, a screen will show the capacity and resolution of the balance. Then the device will be placed in the simple weighing screen.

At first power on, the device starts by activating the default user with the factory settings.



In the weighing screen, the area displaying the weight shows the value of the weight on the weighing plate.

Use the **-0-** key to set a new zero point and reset all tare values.

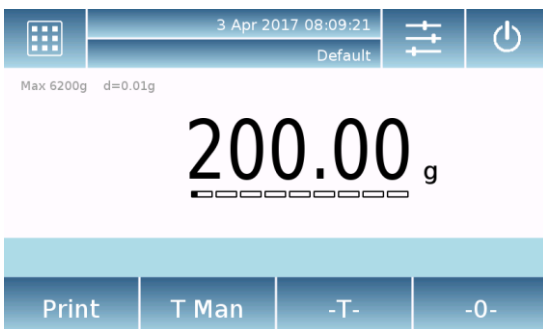

If you work with weighing boxes, first zero the balance. Place the container and press the **"-T-"**key.

Or use the **T Man** key to enter a known tare value manually.



The **Net** symbol on the display indicates the net weight. Press **"Net"** to see the gross weight **"Lrd"**.

"T= " indicates the tare value captured.



Place the material to weight on the balance and wait for the stability symbol to light up before detecting the value.



Press “**Lrd**” and “**Net**” to display the gross and net weights and vice versa.



To reset the balance, remove all items from the plate and press the “**- 0 -**” key.



If you entered a manual tare, press “**T-Man**” and “**C**” key to clear the tare value.

7 Customized settings

This section explains all the customization features of the device. Each function described below will allow you to set it differently for each user.

N.B. Some settings can only be modified by users with administrator permissions.

- Calibration menu
- Setup
- Users setup
- Preferences
- Info
- Service

To access the settings menu, tap the button in the top bar of the display.

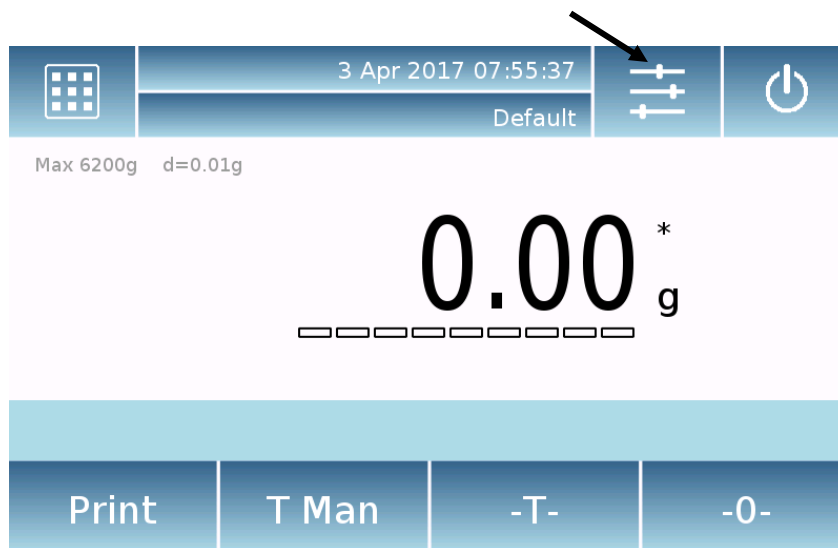

The following screens will be displayed with all the functions of the setup menu.

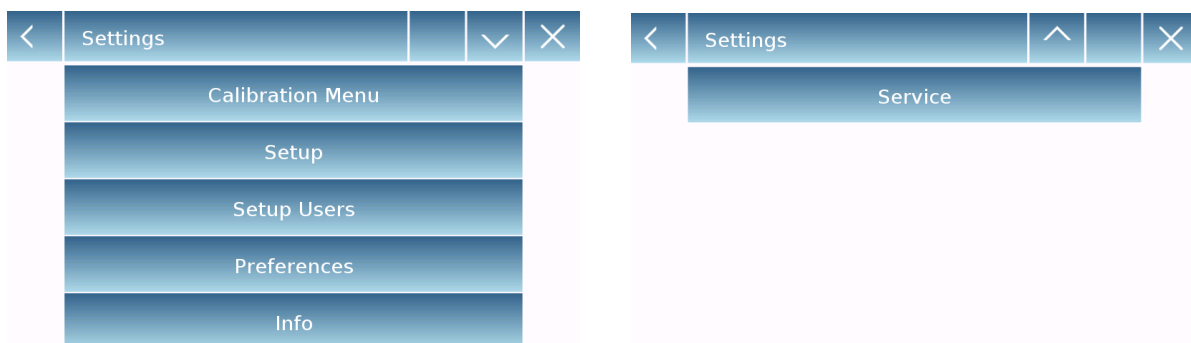

Indicator of the number of pages available.
To scroll through the next and back pages, tap on the arrows.

Return to the previous screen   Exit from the menu



Function indicator not available or not enabled for users without administrator rights.

7.1 Selecting the language

In the settings menu, select the "**Preferences**" function.



Tap "**Language**" in the menu list.

You can select the device's use language.



Then select the desired language.
Automatically, all screens will be translated into the selected language.



N.B. The selected language will only be assigned to the user with whom the selection was made.

7.2 Setting date and time

Select **“Setup”** in the setup menu.

Enter the new date and time values. You can also select the 24-hour or 12-hour format for the hour.

N.B. The date and time setting is not customizable for each user, but once defined it will be changed for all users.

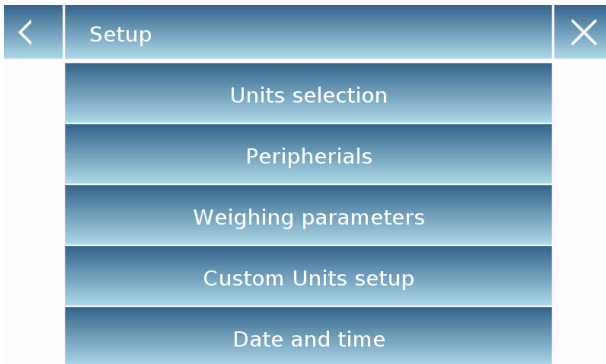

Tap **“Date and time”** in the menu list.



Tap **“Date”** in the menu list to change the date.

Tap **“Time”** in the menu list to change the time

Tap **“24h – 12h”** in the menu list to set the time format.

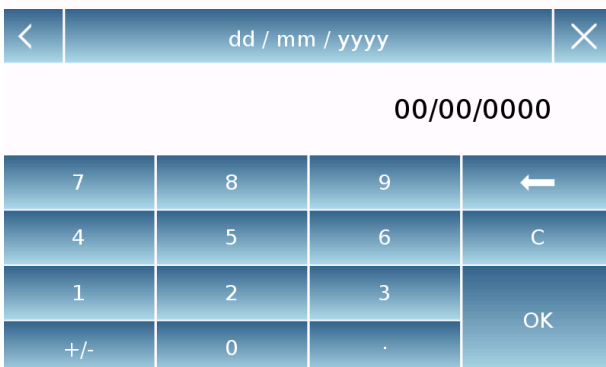

A numeric keypad will be displayed for entering the date and time in **“dd/mm/yyyy”** mode for the date and **“hh:mm:ss”** for the time

Tap **“OK”** to confirm the new settings, **“C”** to delete all entered data or tap **“X”** to exit without changing the value.

7.3 Creating, changing and selecting the user profile

The balance can be customized for multiple users. You can create up to 10 different usage profiles. At the first turn on, the “**Default**” user is enabled and this user cannot be either deleted or renamed.

Each user can then fully customize all the included database device settings. Once you've created your profile, just touch "**User Area**" on the Home screen and select the user you want. All settings for the selected user will then be loaded. From this moment on, any changes made to the enabled user will be stored and made available each time the user is selected.

You can create two types of user:

- **Administrator**
- **Standard**

Creating an administrator user allows the user to access all the device setting features and changing or deleting other users.

Creating a standard user allows the user to access only some of the device setting features. The prohibition display that appears when you touch a feature that is not available for the standard user is as follows:



You must log on with an administrator user to change the protected functions.

Also, after you have created an administrator and standard user, you will be able to assign an access password that will be required each time you select the user and turn on the device.

Below are all operations related to the user modification and deletion. In the settings menu, select the "**Setup Users**"

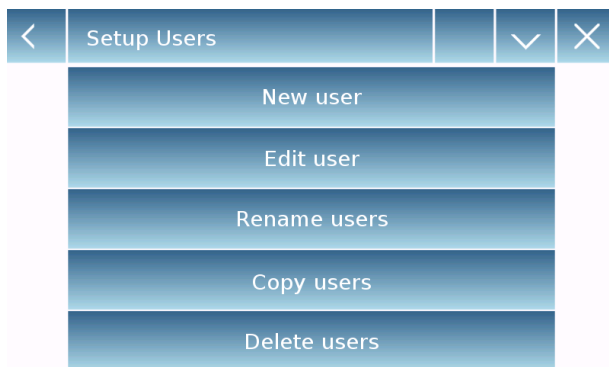

This screen allows you entering the following functions:

- New user
- Edit user
- Rename user
- Copy users
- Delete user
- User Password



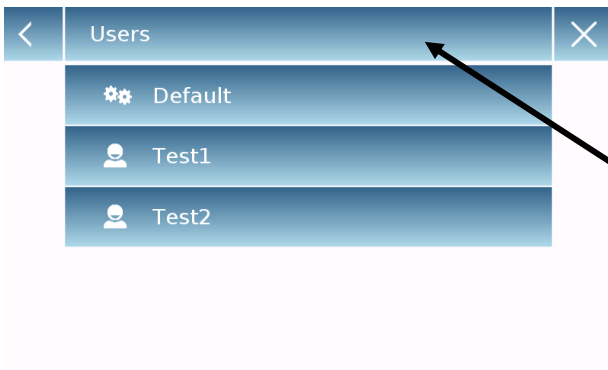

▪ **New user**

By selecting the "New User" function, you can define a new user. The maximum number of users that can be entered is 10. You will be prompted to select whether the user you want to create must have administrator powers or be a standard user.

The keyboard for entering the username will then be automatically activated. The maximum number of characters allowed is 30.

The insertion method distinguishes between uppercase and lowercase letters, so a user entered as "TEST" will be different from a user entered as a "test".

After searching for a new user, go back to the main screen.

Tap the user selection area and select the user you have just created. From now on, all changes to the functions, databases, or analytics results will be associated with the user, and each time they are called, they will be automatically reloaded.

The left-hand symbol of the username indicates the type of user:

Administrator

Standard

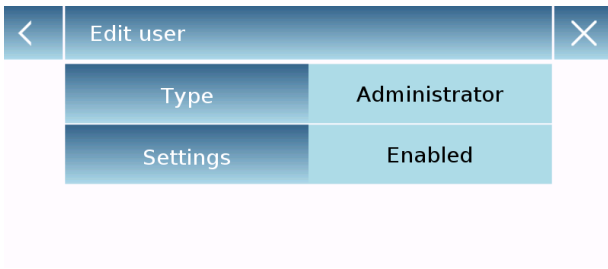

▪ **Edit user**

In the "Edit user " menu, you can change the user type ("Standard or Administrator") and temporarily unlock the standard user locked settings.

Type

If the user is of the standard type in order to modify the user type, a user's password with administrator rights will be required.

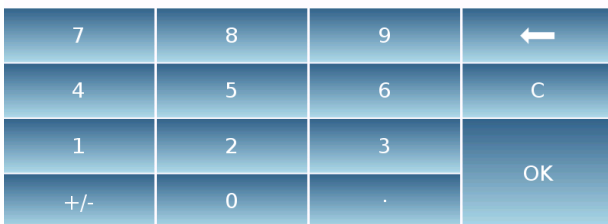

Select "**Standard**" to set the user in standard mode or select "**Administrator**" to set the user with administrator rights.



Settings

Selecting this function will prompt you to enter a user's password with administrator rights.



Then select the "**Enable**" function to temporarily unlock the standard user or select the "**Disable**" function to lock the user again.



After you unlock the user in the base screen on the left side of the username, an open padlock will appear.

Unlocking will remain active until it is locked again through the user editing menu, or when another user is selected or the device is turned off.

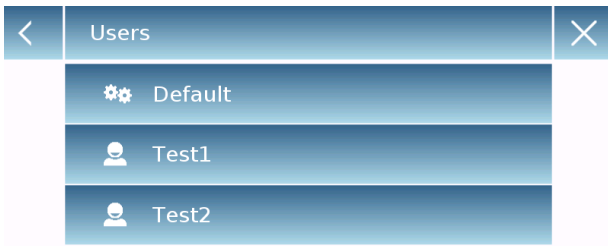

▪ **Rename users**

By selecting the "Rename Users" function, you can change the name of the selected user.

Select the user you want to rename.

The name change keyboard will be displayed.

Tap "X" to cancel the operation or change the name and confirm with the "Enter" key.



▪ **Copy users**

By selecting the "Copy Users" function, you can create a new user with the same configuration as an existing user.

Any databases will not be copied and no password protection will be enabled. To copy the databases of another user, you need to export and import them to the desired user.

Select the user you want to duplicate.

Enter the name to assign to the new user and confirm with the "Enter" key.

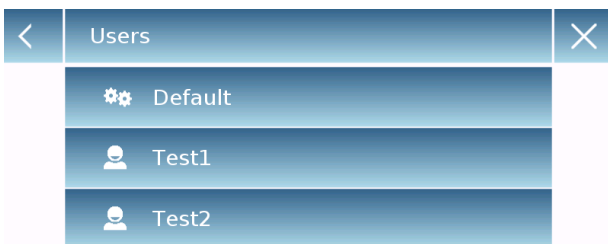

▪ **Delete users**

By selecting the "Delete Users" function, you can permanently delete a user and its databases.

The list of stored users will be displayed, then select the user to delete.

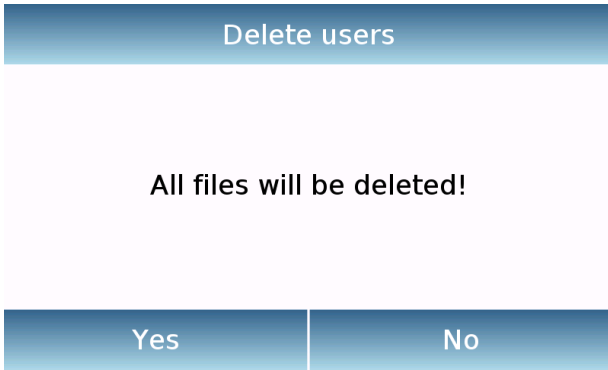

Confirm by tapping the **"Yes"** key or cancel the operation by tapping the **"No"** key.



▪ **User password**

By selecting the "User Password" function, you will be able to assign a "Standard" or "Administrator" user password.

You will then be asked to re-enter the password for confirmation.

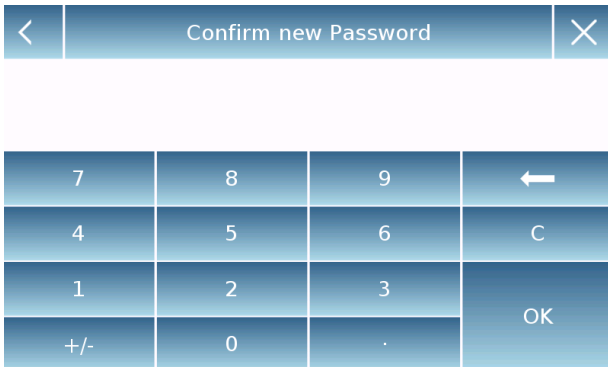

Enter it and tap the **"OK"** key.

From this moment on, every time you want to access the user, you will be required to enter your password.

N.B. Write down your password and store it in a safe place.

Warning! In case of loss, you will only be able to recover the password for the "Standard" user. The recovery procedure is described in chapter 8.3.1.

7.3.1 Recovering and removing passwords

User password protection is applicable to both "Standard" and "Administrator" users. In the first case, if the user forgets its password, you can update it from the "**User Password**" menu.

| | | | | |
|-----|--------------|---|---|----|
| < | Old Password | | | × |
| | | | | |
| 7 | 8 | 9 | ← | OK |
| 4 | 5 | 6 | C | |
| 1 | 2 | 3 | | |
| +/- | 0 | . | | |

After selecting "User Password", you will be asked to enter the "**Old Password**".
Enter an administrator password.

After selecting "User Password" you will be asked to enter the "Old Password".
Enter an administrator password.

| | | | | |
|-----|----------------------------|---|---|----|
| < | New Password (min 4 char.) | | | × |
| | | | | |
| 7 | 8 | 9 | ← | OK |
| 4 | 5 | 6 | C | |
| 1 | 2 | 3 | | |
| +/- | 0 | . | | |

Then enter the "**New password**" to assign to the user.

Confirm the password you have just entered.

From now on, the "Standard" user will have a new login password.

| | | | | |
|-----|----------------------|---|---|----|
| < | Confirm new Password | | | × |
| | | | | |
| 7 | 8 | 9 | ← | OK |
| 4 | 5 | 6 | C | |
| 1 | 2 | 3 | | |
| +/- | 0 | . | | |

N.B.
To remove the password, upon the request for entering the new password and confirmation of the new password, tap the "OK" key without typing any value.

CAUTION! If the lost password is that of an administrator, you will need to contact a Service Center to retrieve it.

7.4 Preferences: language, display appearance, brightness, beeper, functions

For each user, you can set a graphic display, the language of use, the activation tone of the beeper and the brightness of the display. Below are the various options available and their activation mode.

In the settings menu, select the "**Preferences**" function.



The parameters that can be set in the "**Preferences**" menu are as follows:

- Language (see chapter 7.1)
- Appearance
- Brightness
- Beeper
- Functions



Appearance

You can choose between 6 different color combinations and select the desired one by tapping the corresponding key



Brightness

There are 4 levels of brightness on the display. Select the desired one by tapping the corresponding key.

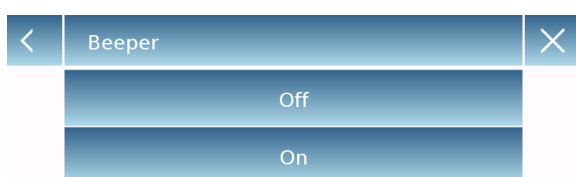

Beeper

The beeper function enables you to activate or deactivate the beeper. When activated whenever you touch the active parts of the touch screen, a beep is released.

| Functions | |
|-----------|--------------|
| F1 | Piece count |
| F2 | Check weight |
| F3 | Weight % |
| F4 | Density |
| F5 | Statistics |

| Functions | |
|-----------|-----------------|
| F6 | Textile |
| F7 | Animal weighing |
| F8 | Max load |
| F9 | Recipe |
| F10 | GLP |

| F5 | |
|----|----------|
| | None |
| | Recipe |
| | Max load |
| | Textile |
| | GLP |

Functions

You can decide which functions to make available and with which sequence to display them for each individual user.

The function display sequence in the relevant screen corresponds to the sequence assigned to function keys F1 to F10

To assign a function, press the key you want to assign and select one from the list of available functions.

To remove a function, press the key corresponding to the function you want to remove and select "**None**" in the list.

| Functions | | | |
|-------------|--------------|----------|---------|
| | | | |
| Piece count | Check weight | Weight % | Density |
| | | | |
| Recipe | Statistics | Max load | ... |

| Functions | | | |
|-----------|-----------------|---------|-----|
| | | | |
| ... | Animal weighing | Textile | GLP |

From the base weighing screen, tap  to access the functions menu.

To switch to the next or previous screen tap the keys:

 Next

 Back

7.5 Setting the weighing parameters

For proper use of the balance, it is important to make the correct weighing parameter settings according to the operating environment.

This section describes the filter parameters, stability, autozero and weighing units.

In the settings menu, select the "**Setup**" function and then the "**Weighing parameters**" function.



In the "**Weighing parameters**" screen, the set values (in the box to the right of the parameter) are immediately verifiable.

By touching the parameter key you want to change, you can change the value.

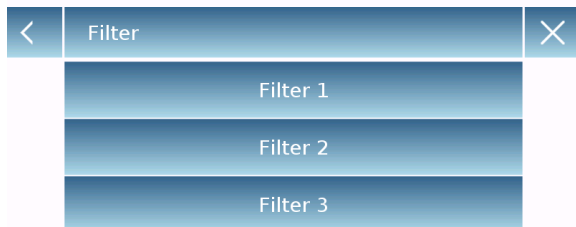

- **Filter:** the filter function allows to speed or slow down the balance response according to weighing requirements and environmental conditions. By selecting Level1, the response will be immediate, but the balance will remain more sensitive to environmental disturbances such as ventilation and vibration. By increasing the level, the response will be slower and the indication more stable.

- **Level 1:** dosage conditions
- **Level 2:** stable conditions
- **Level 3:** unstable conditions



- **Stability:** this function allows you to adjust the balance to the working environment. When using the device in a vibration-free environment, select level 0. The default level is 2. Use level 3 for very disturbed environments.

- **Level 0:** For stable environments.
- **Level 1:** For poorly stable environments.
- **Level 2:** For unstable environments.
- **Level 3:** For heavily unstable environments.



- **Autozero:** automatic zero correction constantly adjusts the zero value. These variations may be due, for example, to dirt that can be deposited on the plate. You can disable this function by selecting "**Off**" mode. Level 1 is the one with minor correction until it reaches level 3E which is the maximum correction.

7.6 Selecting the unit of measurement

Weighing operations can be performed with different units of measurement. Below is shown how to select the desired weighing unit.

In the settings menu, select the "**Setup**" function and then the "**Units selection**" function.



On the "**Units Selection**" screen, all available weighing units are immediately displayed. Tap the desired unit to select it and enable it.



The last three units of measure, **K1**, **K2**, **K3**, are customizable units. For reference, refer to the chapter "**Selecting the custom measurement unit**".

N.B.: The measurement unit selection can also be made directly from the weighing screen; by tapping the symbol of the current unit displayed, you will have access directly to the list of available units.

7.7 Selecting the custom measurement units

You can define up to three custom units per user. This allows you to perform calculations directly from weighing detection (i.e. volume, paper grammage g/m³). The custom weight unit can be recalled in all fields and menus where the units can be selected.

In the setup menu, select the "**Setup**" function and then the "**Custom units setup**".

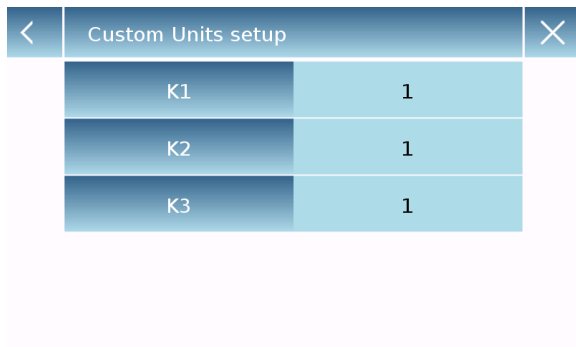

| Custom Units setup | |
|--------------------|---|
| K1 | 1 |
| K2 | 1 |
| K3 | 1 |

On the "**Custom units setup**" screen, you can select one of the three units K1, K2, K3 available to personalize it.

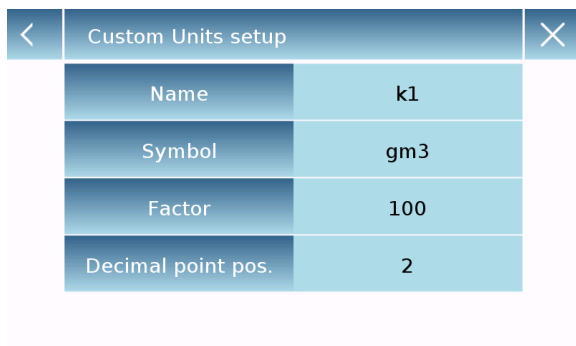

| Custom Units setup | |
|--------------------|-----------------|
| Name | k1 |
| Symbol | gm ³ |
| Factor | 100 |
| Decimal point pos. | 2 |

After the selection, enter the following data:

- **Name:** enter the unit identifier (max 15 characters).
- **Symbol:** enter the symbol you want to assign to the unit of measurement (max. 3 characters). The weight units g, kg, lb and so on. are not allowed
- **Multiplier factor:** enter the multiplicative factor with which the weighing result has to be calculated
- **Decimal point position:** enter the position of the decimal point with which you want to display the result (i.e. entering 1, the value 123,123 will be displayed as follows: 12312,3)

7.8 Calibrating and setting the calibration mode

Electronic balance performs mass measurements using gravity (g). Differences in geographic regions and altitude vary the gravity acceleration (g).

Therefore, in order to obtain accurate measurements, the balance must be adapted to the place of use and environmental conditions. This adjustment is performed by the calibration function.

Select the "**Calibration menu**" function in the settings menu.

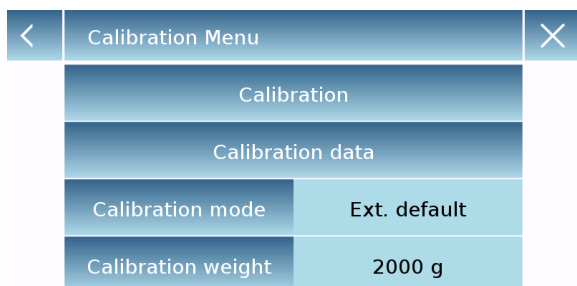

In the calibration menu, you can calibrate, display and print the data for the last calibration and set the calibration mode.

Before performing the calibration procedure, check that the plate is empty.

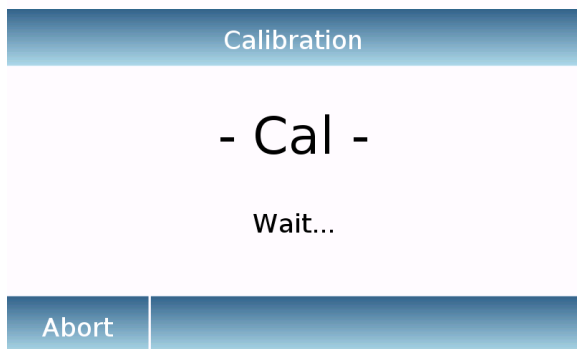

- **Calibration:** By tapping the calibration key, the calibration procedure corresponding to the set calibration mode will be activated.

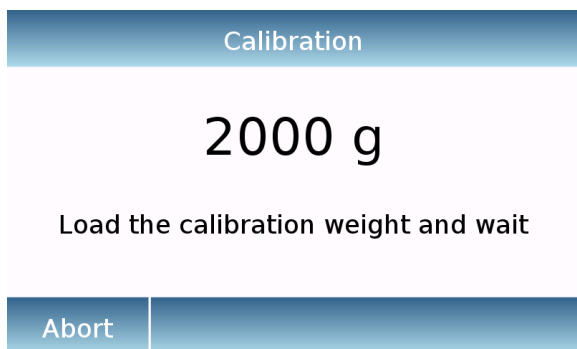

Load the required calibration weight or tap the "**Abort**" button to cancel the calibration procedure.



Wait for weight capture.

If the operation is successful, the weighing screen will display with the calibrated weight value.

Remove the weight from the plate.



- **Calibration date:** in the calibration data screen, you can check the date when the last calibration was performed, the mode with which it was performed, the weight value used, and the correction made with respect to the previous calibration. By tapping the "**Print**" button, you can print the displayed data.

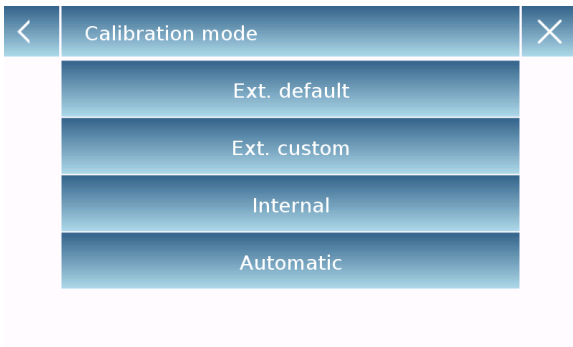

- **Calibration mode:** the balance can be set to calibrate with two different modes:

External default

By selecting the default calibration mode when the calibration command is given, the required weight will be the factory default setting, the value of which will vary depending on the balance model.

External custom

By selecting the external custom" calibration mode, you can set a custom calibration weight value.

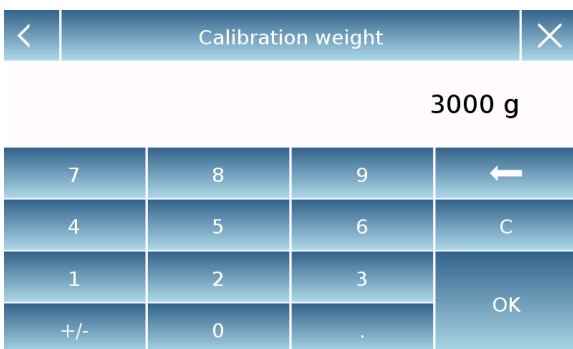
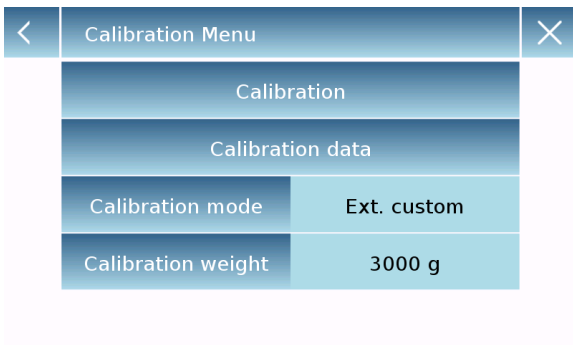

After selecting the "mode of choice", tap the Weight Setting button to set the desired weight value.

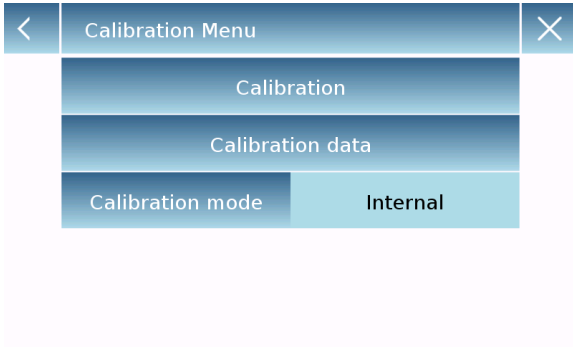

Internal*

By selecting the internal calibration mode when the calibration command is given, the balance is automatically calibrated through the motorized auto-calibration internal system.

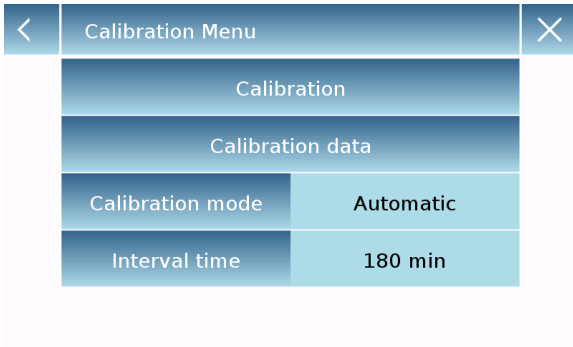

Automatic*

By selecting the automatic calibration mode, the balance automatically calibrates when the ambient conditions change or within a set time of 60 to 999 minutes. Also with this mode, you can calibrate each time you want by tapping the "Calibration" key.

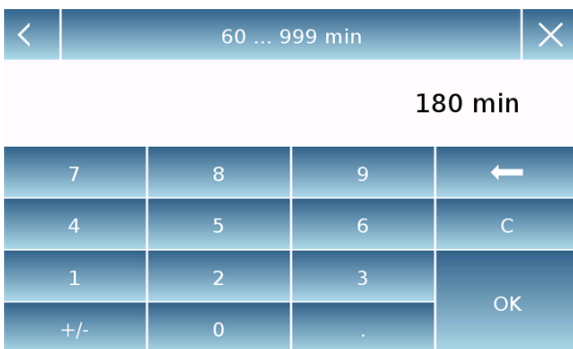

To change the auto-calibration range, tap the "**Calibration Range**" key and set the desired range between 60 and 999 minutes.

*** The internal and automatic calibration mode is only available for auto-calibration models.**

7.9 Setting the peripherals

This section describes the features and settings of the RS232 and USB serial outputs that the device is equipped with.

In the setup menu, select the "**Setup**" function and then the "**Peripherals**" functions.

| Peripherals | |
|---------------|-----------|
| Printer | Generic |
| Baud rate | 9600 Baud |
| Stability | Off |
| Print heading | On |
| Line feed | 0 |

In the "**Peripherals**" menu screen, you can immediately check the values of the parameters set (in the box on the right of the parameter).

Tapping the parameter key to be set will activate its screen with the list of the various selectable options.

| Peripherals | |
|-------------------|-----|
| GLP | Off |
| Time - date | Off |
| Balance cal. data | Off |

| Printer | |
|-----------------|--|
| DPP 250 | |
| DPP 350 | |
| T/LP 50 | |
| File on Usb-Key | |
| Generic | |

- **Printer:** this function allows you to select the device connected to the serial output.
 - **Dpp250:** command print, by touching the "**Print**" button for the Dpp250 printer.
 - **Dpp350:** command print, by touching the "**Print**" button for the Dpp250 printer.
 - **Tlp50:** command print, by touching the "**Print**" button for the Tlp50 printer.
 - **Generic:** command print, by touching the "**Print**" button for generic serial type printer.

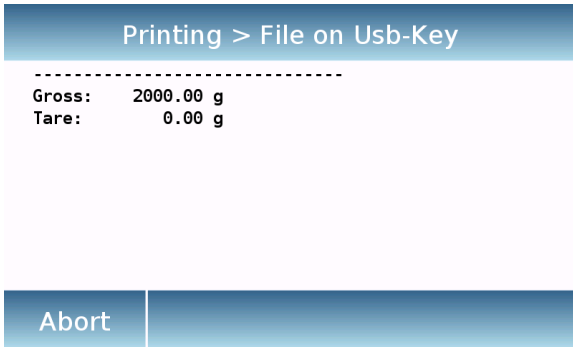

➤ **File on Usb-Key:** command print, touching the "Print" button will print to file. In order to use this mode, you will need a USB stick to save the files. (You can use a dedicated USB stick for that purpose only). With the "File on Usb_Key enabled" mode before executing the print command, verify that the save USB stick is inserted in the USB port on the left side of the device. While saving the file on the screen, you can scroll through the information that will be saved in the file.

At the end of the save, the name of the file assigned automatically will appear on the screen.

The USB stick will then contain a compressed file with a text file (.txt) showing the weighing data or the result of the function used.

Example of printing with density function.

Liquid density:
1.0 g/cm³

Air P.: 200.04 g

Liq. P.: 100.02 g

Result (Solid Dens.):
2.0000 g/cm³

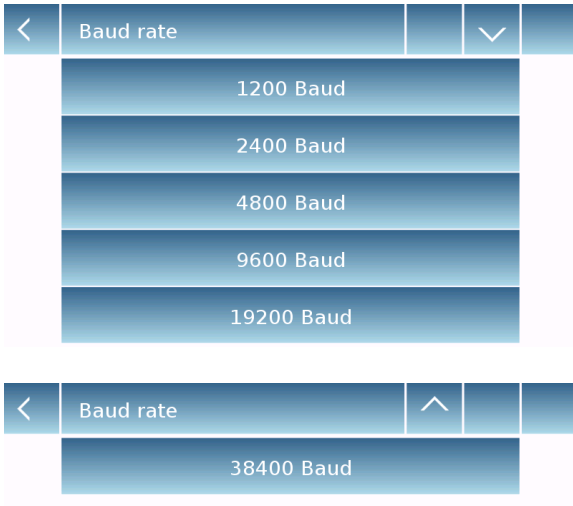

- **Baud Rate:** serial transmission speed selection parameter. Selectable speeds are as follows:

- **1200 Baud.**
- **2400 Baud.**
- **4800 Baud.**
- **9600 Baud.**
- **19200 Baud.**
- **38400 Baud.**

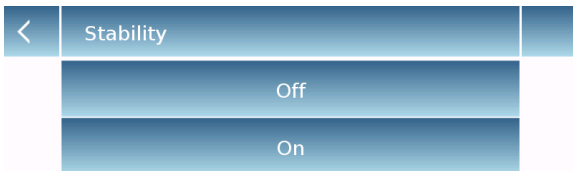

- **Stability:** check of the stability before data is transmitted. It is possible to decide whether to enable or disable stability control before printing the weight value:

- **On.** Check enabled.
- **Off.** Check disabled.

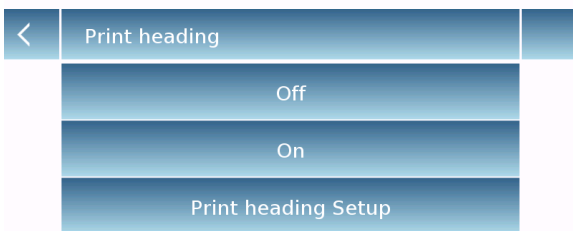

- **Print heading:** this function allows you to place a header at the beginning of the receipt. The function can be:

- **On.** Bill heading enabled.
- **Off.** Bill heading disabled.
- **Print heading Setup:** Activation of the screen for inserting the desired text for the receipt header.

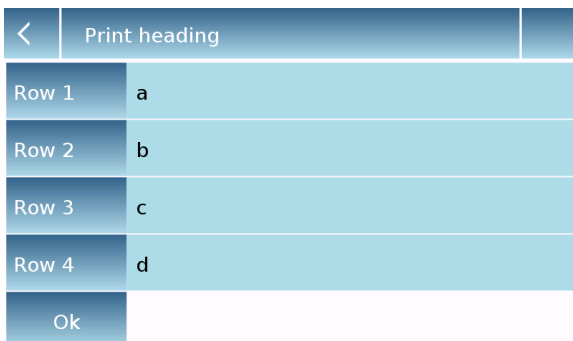

In the print header screen, tap the rectangles that indicate the line number to automatically enable the alphanumeric keypad and enter the desired text with a maximum number of 40 characters per line.

Tap the "**Ok**" key to confirm the entered text.

NB. You can enable and disable the bill header function without losing the inserted text, which will remain stored until the contents of the various lines are deleted.

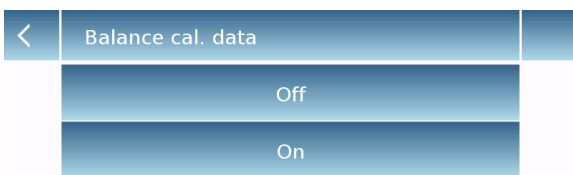
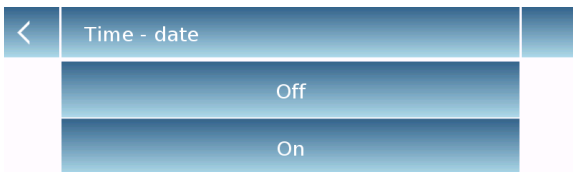
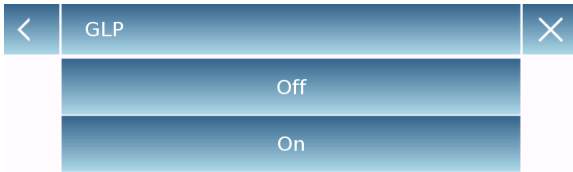
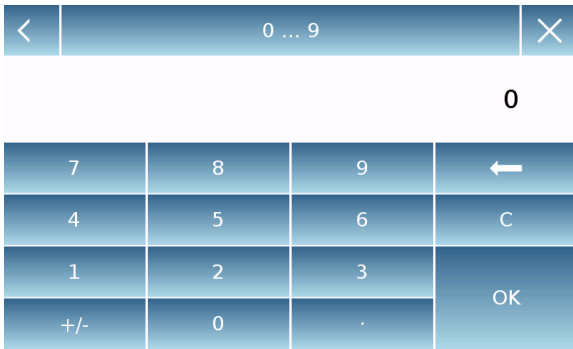

- **Paper progress:** this function allows you to set a blank number of lines to add at the end of the bill to allow the printer to exit from it. The input numeric keypad will automatically turn on, so enter the desired number of lines (between 0 and 9) and tap the "Ok" key to confirm the entered number.

- **G.I.p.:** this function allows you to enable or disable the g.i.p. data printing after user have entered it

- **On.** g.i.p. data print enabled.
- **Off.** g.i.p. data print disabled.

For information entry and G.I.p. database management, see **chapter 9.9**

- **Time and date:** this function enables you to enable or disable the time and date printing.

- **On.** Calibration data print enabled.
- **Off.** Calibration data print disabled.

Time and date printing cannot be deactivated with the G.I.p. function enabled.

- **Balance cal. data:** this function enables you to enable or disable the calibration data printing of the balance.

- **On.** Calibration data print enabled.
- **Off.** Calibration data print disabled.

7.10 Info about the software

This section explains how to view information about the software versions of the tool.

In the settings menu, select the "**Setup**" function then the "**Info**" one.

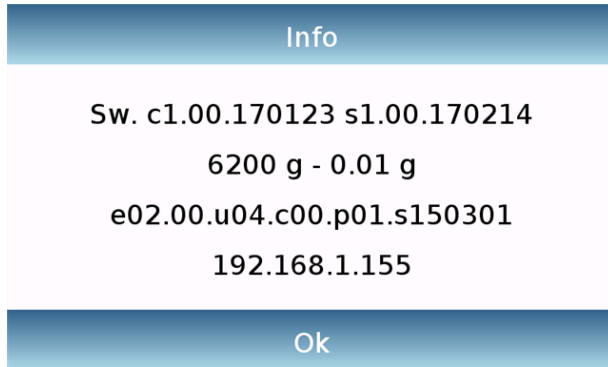

The information on the Info screen will be requested by the technical staff in case of assistance request.

7.11 Service

This section describes all the functions related to the Service and Backups of the device data.

In the settings menu, select the "**Setup**" function then the "**Service**" one.

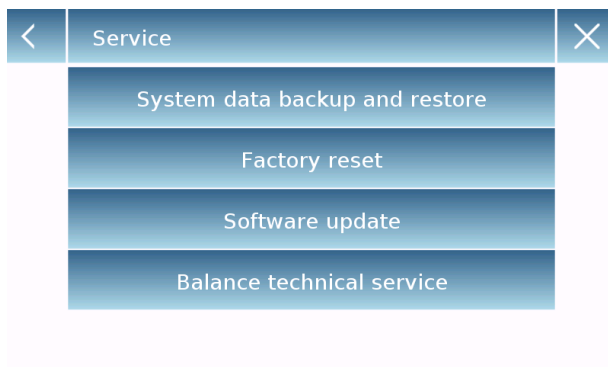

The functions available in the **Service** menu are as follows:

- System data backup and restore
- Factory reset
- Software update
- Balance technical service

7.11.1 System data backup and restore

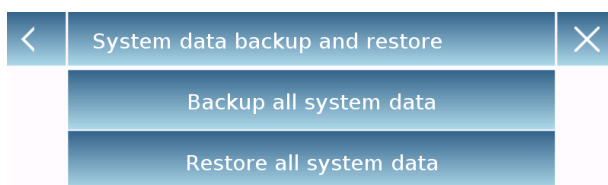

You can back up the system completely or restore data and configuration previously saved on a USB stick.

This section describes the steps to be taken to export or import the data.

N.B. It is recommended to use an empty USB stick that is dedicated to data save and recovery operations.

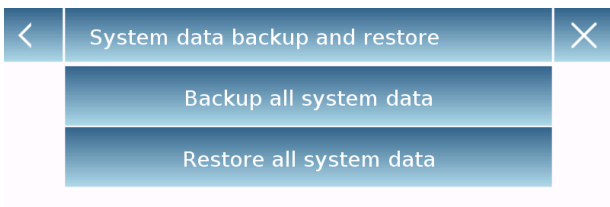
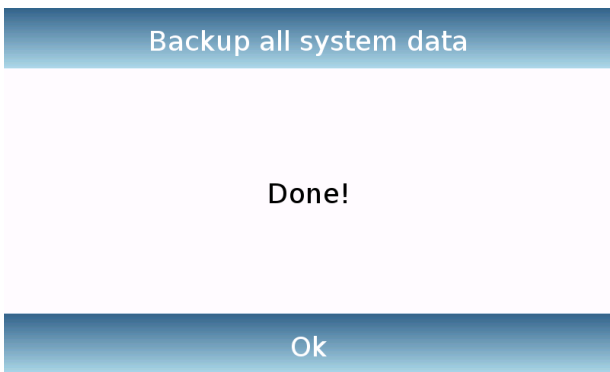
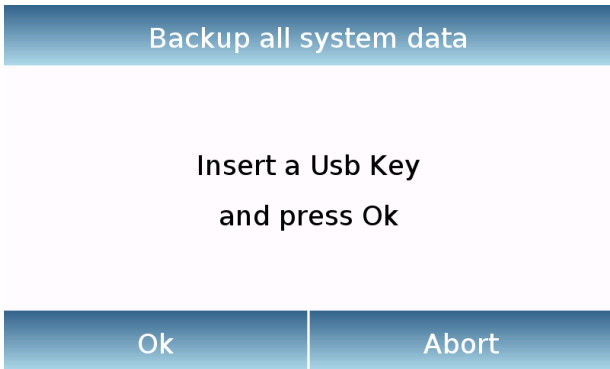

- **System backup:** this command allows you to save all users and their configurations stored in the system, including its drying database and saved test results.

You must have a USB stick to back up.

Insert the stick into the USB port on the left side of the device, and press the "OK" key. Tap the "Abort" button to cancel the backup operation.

If the USB stick is inserted successfully, after confirmation, the alphanumeric keypad will automatically be displayed for entering the name that you want to assign to backup.

A screen with the message "Completed!" will report that the export operation was successful.

A backup folder with the assigned name was then created in the USD stick.

Opening the folder, you will find a set of files and subfolders that contain all the data.

N.B: Do not modify or rename any files to avoid damaging the content. The folder will be automatically restored to the device by using the System Restore command.

This folder will be automatically restored to the device by using the System Restore command.

- **System restore:** this command allows you to restore all users and their system configurations previously exported with the backup command on a USB stick.

N.B. You can import the exported data from another device, so you can configure multiple device s with the same users and the same settings.

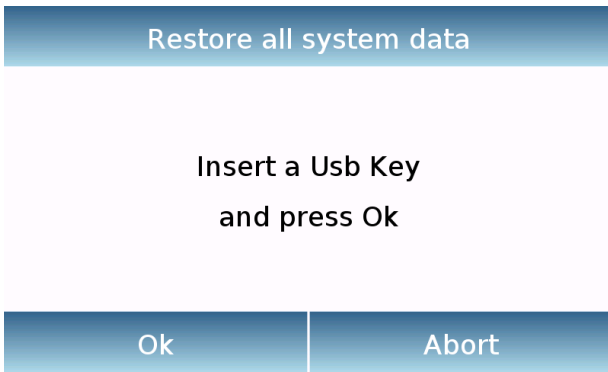

Insert the USB stick into the USB port on the left side of the device, and press the "OK" key.
Tap the "Abort" button to cancel the system restore operation.



If the USB stick is inserted correctly, after confirmation, the alphanumeric keypad will automatically be displayed for entering the name of the backup you want to restore.

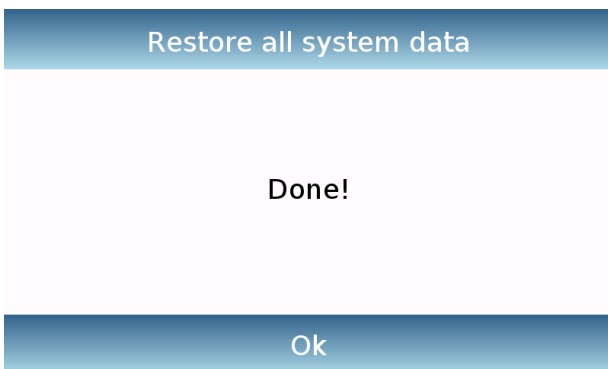

A screen with the message "Completed!" will report that the system recovery operation was successful.

7.11.2 Factory reset

You can perform a total reset of the device to bring it back to the initial conditions.

Tap the "**Factory Reset**" button, confirm by touching the "Yes" button, or cancel the operation by tapping the "No" button.

N.B. Be careful as all the data of all users including their databases will be lost. If you want to save them, make a backup before the factory reset.

7.11.3 Software update

You can make any software updates provided by the manufacturer via the USB port.

Below are the steps to be taken to upgrade.

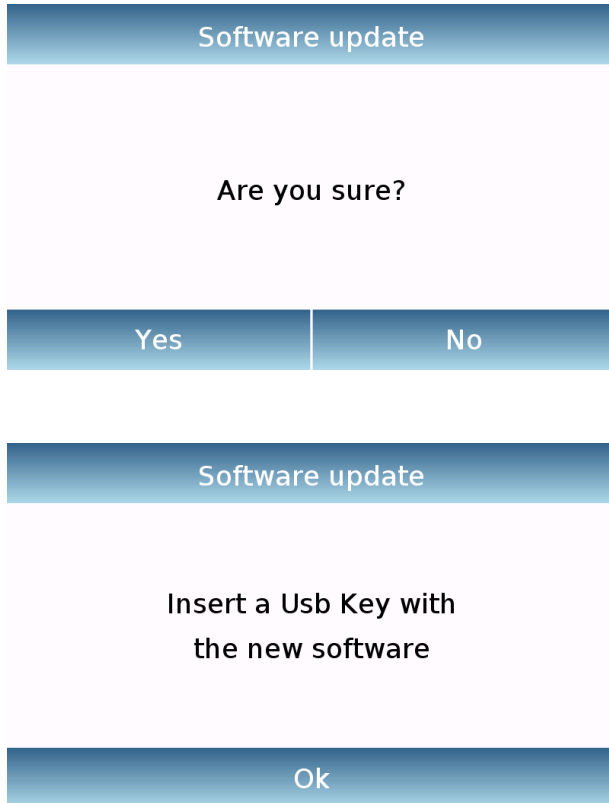

Selecting the "Software Update" function will display the screen with the confirmation request. Select "**No**" to cancel the operation, or "**Yes**" to continue.

Insert the USB stick into the port on the left side of the device by checking before the stick is loaded with the upgrade program supplied by the manufacturer and confirm with the "**Ok**" key.

If the selected file is correct, the upgrade operation will be enabled and a displayed counter will indicate the progress status.

N.B. Once the software upgrade operation has begun, do not power off the device until the operation completes.

During the upgrade, the device will turn off and restart automatically; do not press any key, but wait for the operation finished successfully indication.

7.11.4 Balance technical service



The technical service function of the balance can be accessed by password only to the authorized technical personnel.

8 Functions menu

This section describes all the functions available for weighing. All of the features described below are customizable in their databases for each user; they can be enabled, disabled, and sequenced according to its usage needs. (See section on preferences in the functions section.)



So each time you change the user, its function settings will vary.

Tap the button , to access the functions menu.

Use the keys ,  to scroll through the displayed back and next pages.

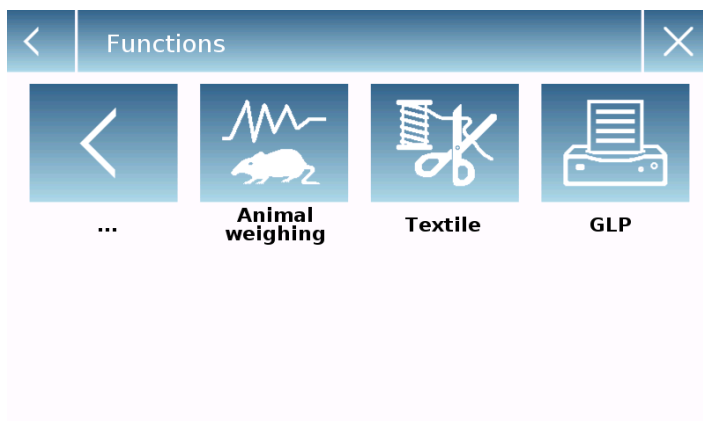
Tap the icon corresponding to the function, you want to access the relevant settings.



To exit the functions menu, tap the button  or .

8.1 Using the database

All functions can be customized for each user by storing the desired modes and items through the relevant database.

The following are the search, save, delete, and editing functions for all databases. For entering data in the database, refer to the paragraph corresponding to the desired function.

After selecting the desired function, tap the "**Database**" key to access the database menu for the desired function.



- Every time a new user is created, the database will be completely empty. The following describes all the functions available to all databases:
- **Selection by name:** by tapping this key you can call up a program by entering the corresponding name.
- **Selection list:** by tapping this button you can call up a program by selecting it from a list.
- **New:** insert new record (refer to the paragraph corresponding to the desired function).
- **Edit:** by tapping this button, you can access the editable parameters of the function.
- **Delete:** tap this button to delete one or more previously stored records.
- **Print:** by tapping this button, you can select a record and print it.
- **Export (Usb):** by tapping this button you can export the database to the USB stick.
- **Import (Usb):** by tapping this key, you can import a previously predefined database from a USB stick.

Use the keyboard to enter the name to assign to the new record. The maximum number of characters that can be entered is 30.

Tap the "**Enter**" key to confirm.



8.2 Function for counting the pieces

The pieces counting function allows you to count the pieces through sampling with a certain number of pieces or entry of the value of the average weight of the pieces to be counted.

To access the function from the "Functions" menu, tap the "**Piece count**" icon.

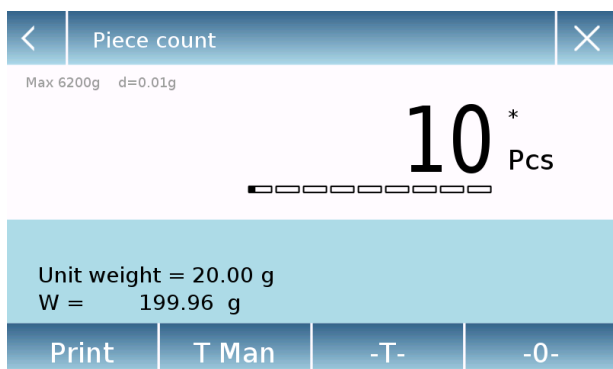
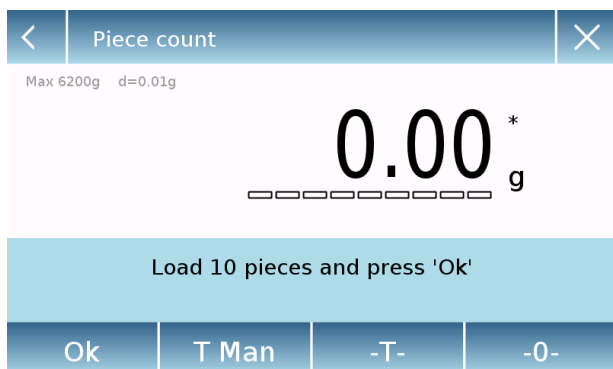
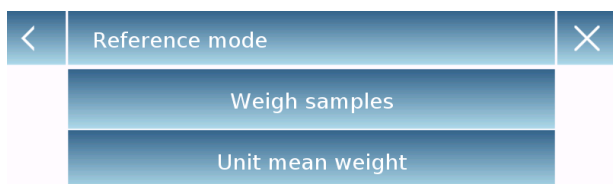
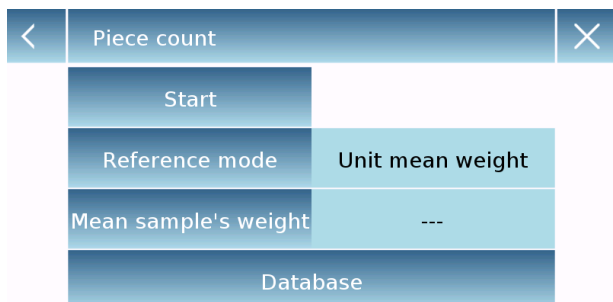

Parameters entry:

Mode:

By tapping this key, you can select the count mode:

- **Weigh samples.**

Counting by sampling a certain number of pieces. Enter the number of samples you want to use for the count by tapping the "Number of samples" key.

- **Unit mean weight.**

Count by entering the weight value of the single piece to be counted. Enter the weight value by tapping the button "Unit mean weight"

Start:

After selecting the count mode, tap the "Start" button to perform the count of the pieces.

Carry out the container tare if necessary, in the case of sample counting before counting, it will be required to load the number of pieces chosen (for sampling) on the plate, while in the mode with average unit weight, you can go directly to the count of the pieces.

| | | | | |
|-------------------|-------------|--|---|---|
| < | Piece count | | ∨ | × |
| Selection by name | | | | |
| Selection list | | | | |
| New | | | | |
| Edit | | | | |
| Delete | | | | |

| | | | | |
|----------------|---------------|--|---|---|
| < | Q1 | | ∨ | × |
| Description | 1A | | | |
| Reference mode | Weigh samples | | | |
| Samples number | 10 | | | |
| Options | Statistics | | | |
| ... | | | | |

| | | |
|-------------|---------|---|
| < | Options | × |
| None | | |
| Statistics | | |
| Check value | | |

| | | | | |
|---------------|-----|-----|-----|---|
| < | Q1 | ∧ | | × |
| Nominal value | --- | | | |
| T2+ | --- | T2- | --- | |
| T1+ | --- | T1- | --- | |
| Save | | | | |

Database:

By tapping the "Database" key, you can create a custom counting database of different items with different methodologies. Using the database in addition to the count of the pieces, you can perform statistical count control and use up to two threshold levels for packing control.

Tap the **"New"** key and enter the name of the new record to be stored.

- **Description:** enter a description of the item.
- **Mode:** select the count mode.
- **Samples number/ Unit mean weight:** enter the number of samples or the average unit weight of the pieces.
- **Options:** you can select the statistical control by activating the "Statistics" function or by controlling the pieces by activating the "Control of value" function.

Statistics:

- To enable this function, you need to include:
- **Nominal value:** enter the nominal value of the number of pieces to be controlled.
- **T2+, T2-, T1+, T1-:** enter the error tolerance threshold values. (Optional entry).
- **Save:** tap the "Save" button to store the recorded record.

| | | |
|-------------|------|---|
| < | Q1 | × |
| Description | A1 | |
| Low limit | 10 g | |
| Up limit | 20 g | |
| Sound | Off | |
| Save | | |

Check weight:

- To enable this function, you need to enter:
- **Lower limit:** enter the minimum number of acceptable pieces.
- **Upper limit:** enter the maximum acceptable number of pieces.
- **Sound:** you can activate or deactivate the beep function when the number of pieces is within the set range.
- **Save:** tap the "Save" button to store the recorded record

8.2.1 Pieces count screen with "Statistics" function.

The following describes the pieces counting functions with statistical calculation.

Parameters used for counting

A1
Reference mode = Weigh samples
Samples number = 10
Options = Statistics
Nominal value = 10 Pcs
T2+ = 5 %
T1+ = 2 %
T1- = 2 %
T2- = 4 %

Statistics

| | |
|-----------------------|---------|
| Samples = | 3 |
| Minimum value = | 10 Pcs |
| Maximum value = | 14 Pcs |
| Difference = | 4 Pcs |
| Sum = | 36 Pcs |
| Average = | 12 Pcs |
| Standard deviation = | 2 Pcs |
| Coeff. of variation = | 16.67 % |
| Out T2+: 2 | 66.7 % |
| Out T1+: 0 | 0.0 % |
| Out T2-: 0 | 0.0 % |
| Out T1-: 0 | 0.0 % |

Weights performed

| | | |
|--------|-----|--------------|
| N. 001 | V = | 10 Pcs |
| N. 002 | V = | 12 Pcs > T2+ |
| N. 003 | V = | 14 Pcs > T2+ |

Tap the "Ok" key to capture a new weight and tap the "End" key to end the capture and perform the final statistical calculation.

8.2.2 Pieces count screen with "Check weight" function.

The following describes the pieces counting functions with check weight.

By tapping the "i" key you can see the parameters used for counting the pieces.

Max 6200g d=0.01g

10^{*} Pcs

0 10 Pcs 11 Pcs

Unit weight = 20.00 g
W = 199.97 g

Print T Man -T- -0-

Q1

A1
Reference mode = Weigh samples
Samples number = 10
Options = Check value
Low limit = 10 Pcs
Up limit = 11 Pcs
Sound = Off

Ok

Max 6200g d=0.01g

14 Pcs

0 10 Pcs 11 Pcs

Unit weight = 20.00 g
W = 270.88 g

Max 6200g d=0.01g

3 Pcs

0 10 Pcs 11 Pcs

Unit weight = 19.35 g
W = 59.65 g

The pieces number control bar is yellow when the number of pieces loaded is lower than the minimum threshold. It is green when the pieces are within the set range (with the beep indication when activated) and red when the number of pieces exceeds the upper threshold set.

8.3 “Check weight” function.

This function allows you to define three different weight check methods:

- **Weight check with upper level threshold**
- **Weight control with lower level threshold**
- **Weight control within the two thresholds.**

To access the function from the "Functions" menu, tap the "**Simple**" icon.

| | |
|--------------|------|
| Check weight | |
| Start | |
| Low limit | 10 g |
| Up limit | 20 g |
| Sound | Off |
| Database | |

To activate the function, enter the values for the "**lower limit**" or "**upper limit**" or both, according to the method you want.

Lower Limit, Upper Limit:

In the Limit Input screen, you can select the unit of measurement to be used for testing by tapping the "**Unit**" key.

To deactivate the limit, enter the value "0" or tap the "C" key and then tap the "OK" key.

| | | | |
|----------|---|---|-------|
| Up limit | | | |
| 20 g | | | |
| 7 | 8 | 9 | Units |
| 4 | 5 | 6 | C ← |
| 1 | 2 | 3 | OK |
| +/- | 0 | . | |

Beeper: enable or disable the beeper. In case of enabling when the weight value is within the set range, a beep is release.

Start:

After entering the required data, tap the "Start" button to activate the weight check function.

Database:

By tapping the "database" button, you can create a custom weight check database with different items and methods.

Tap the "**New**" key and enter the name of the new record to be stored.

Enter the required data:

- **Description:** enter a description of the item.
- **Lower limit**
- **Upper limit**
- **Sound**

| | |
|-------------|------|
| Q1 | |
| Description | A1 |
| Low limit | 10 g |
| Up limit | 20 g |
| Sound | Off |
| Save | |

Then tap the "**Save**" button to save the record.

8.3.1 "Check weight" screen function

The Check weight function screen is described below.

By tapping the "i" key, you can see the parameters used for counting the pieces.

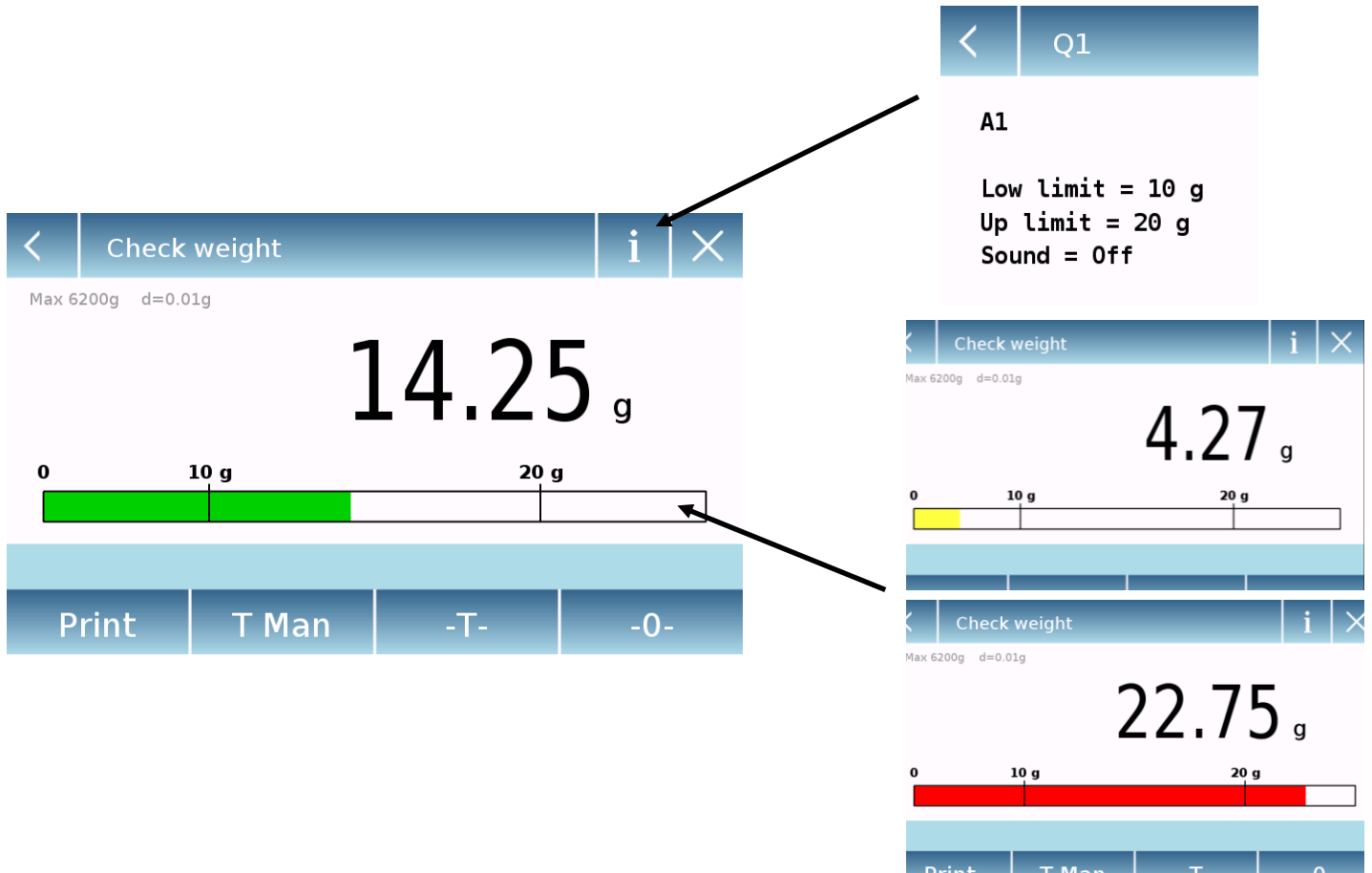

The Check weight bar is yellow when the loaded weight is lower than the minimum threshold and green when the weight is within the set range (with the beep indication when activated) and red when the weight is greater than the upper threshold set.

8.4 “Weight %” function

This function allows you to determine the weight percentage of a sample based on a reference weight.

The value of the reference weight can be obtained by a sample weight or manually entering the weight value.

To access the function from the "Functions" menu, tap the "**Weight %**" icon.

| | | |
|-----------------|------------------|---|
| Weight % | | ✕ |
| Start | | |
| Reference mode | Autom. reference | |
| Reference value | --- | |
| Database | | |

Select the mode:

Automatic reference:

Selecting this mode upon startup will require you to load the reference sample weight (100%) on the weighing plate.

| | | |
|-----------------|------------------|---|
| Weight % | | ✕ |
| Start | | |
| Reference mode | Manual reference | |
| Reference value | 10 g | |
| Database | | |

Manual reference:

Selecting this mode requires you entering the reference weight value (100%). Then tap the "**Reference Weight**" key and enter the weight value in the input screen and select the desired unit of measurement.

Start:

after selecting the desired mode and entering the required data, tap the "Start" button to run the "Weight%" function.

| | | | |
|-----------------|------------------|---|---|
| Q1 | | ▼ | ✕ |
| Description | A1 | | |
| Reference mode | Manual reference | | |
| Reference value | 10 g | | |
| Options | Statistics | | |
| ... | | | |

Database:

by tapping the "Database" button, you can create a custom database to perform weighing in percent with different methodologies.

Using the database in addition to the simple percentage weighing, you can perform statistical weighing checks or set up to two levels of weight check thresholds. Tap the "**New**" key and enter the name of the new record to be stored.

- **Description:** enter a description of the item.
- **Mode:** select the weight reference mode.

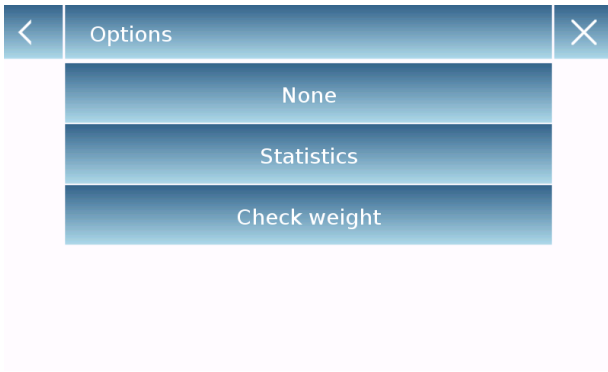

- **Reference weight:** enter the reference weight value in manual weight mode.
- **Options:** you can select the statistical control by activating the "Statistics" function or the weight check by activating the "Value check" function.

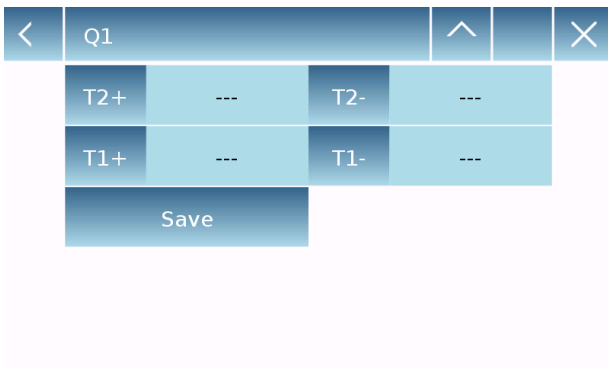

Statistics:

To enable this function, you need to enter:

- **Nominal value:** Enter the nominal weight value to be checked.
- **T2+, T2-, T1+, T1-:** enter the error tolerance threshold values. (Optional entry).
- **Save:** tap the "Save" button to store the recorded record

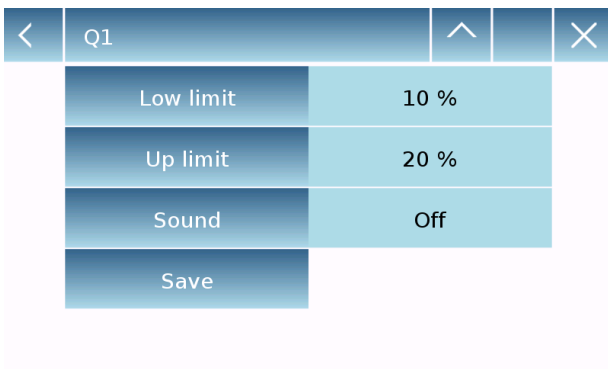

Check weight:

To enable this function, you need to enter:

- **Lower limit:** enter the minimum acceptable weight value.
- **Upper limit:** enter the maximum acceptable weight value.
- **Sound:** you can activate or deactivate the beeper function when the weight is within the set range.
- **Save:** tap the "Save" button to store the recorded record

8.4.1 Screen of Weight % with "Statistics" function.

The following are the functions of the weighing% with statistical calculation.

Parameters used for the weight %

A1
 Reference mode = Manual reference
 Reference value = 10 g
 Options = Statistics
 T2+ = 5 %
 T1+ = 2 %
 T1- = 2 %
 T2- = 4 %

Weighting statistics

| | |
|-----------------------|----------|
| Samples = | 4 |
| Minimum value = | 55.8 % |
| Maximum value = | 2110.0 % |
| Difference = | 2054.2 % |
| Sum = | 6177.6 % |
| Average = | 1544.4 % |
| Standard deviation = | 993.6 % |
| Coeff. of variation = | 64.34 % |

| | |
|-------------------|-------------------|
| Out T2+: 3 75.0 % | Out T2-: 1 25.0 % |
| Out T1+: 0 0.0 % | Out T1-: 0 0.0 % |

Weighting performed

| | | |
|--------|-----|---------------|
| N. 001 | P = | 100.0 % |
| N. 002 | P = | 100.0 % |
| N. 003 | P = | 300.0 % > T2+ |
| N. 004 | P = | 50.0 % < T2- |

Max 6200g d=0.01g

55.8 %

○○○○○○○○○○○○○○

Load the sample No. 5 and press 'OK'

Reference = 10 g
W = 5.58 g

| | | | | |
|----|-----|-------|-----|-----|
| Ok | End | T Man | -T- | -0- |
|----|-----|-------|-----|-----|

Last weighing delete key.

Tap the "Ok" key to capture a new weight and tap the "END" key to end the capture and perform the final statistical calculation.

8.4.2 Screen of Weight % with "Check weight" function.

The following are the functions of the weight% with weight check.

By tapping the "i" key, you can see the parameters used for weight check.

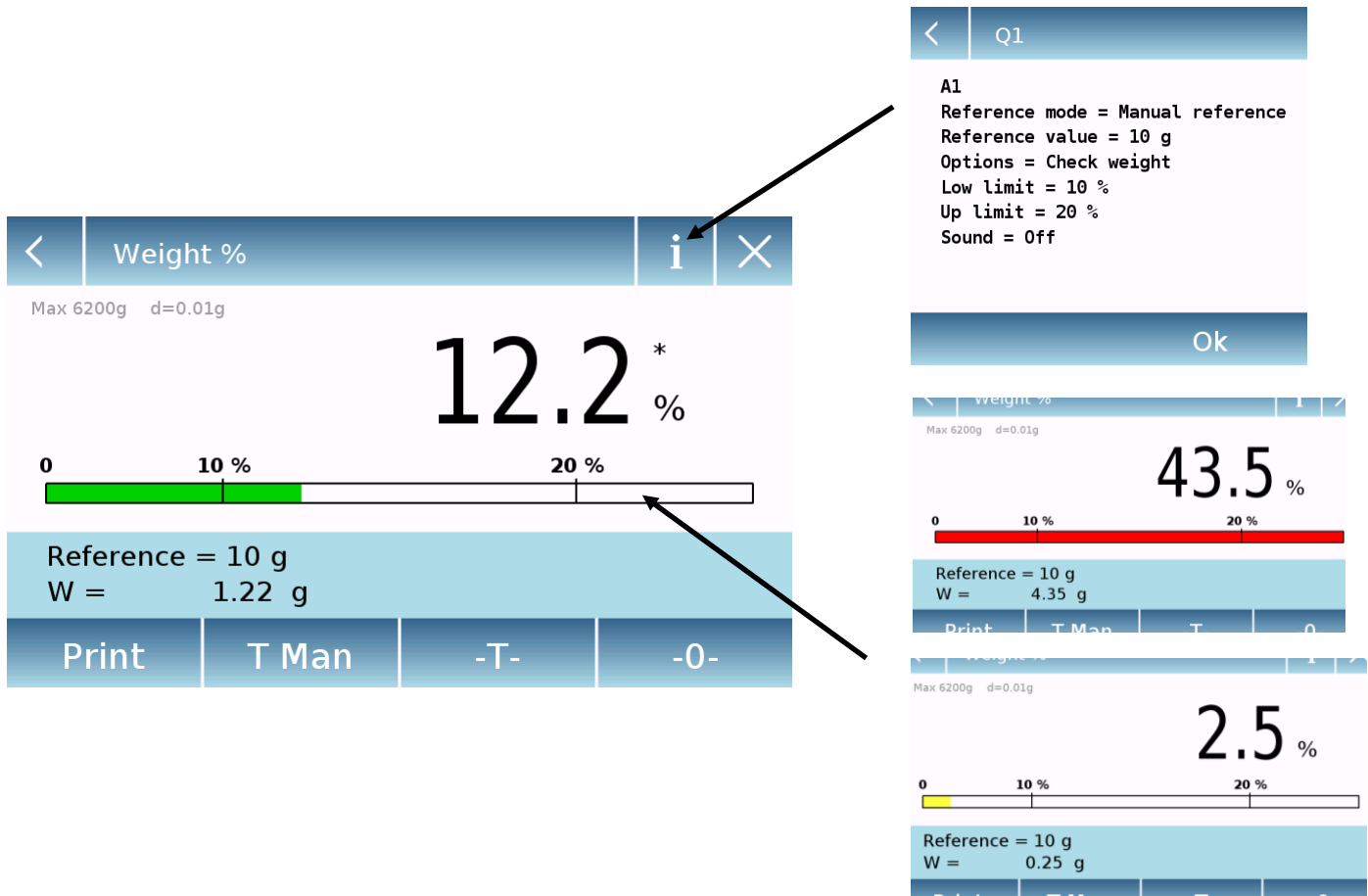

The weight check bar is yellow when the loaded weight is lower than the minimum threshold, green when the weight is within the set range (with the beep indication when activated) and red when the weight is greater than the upper threshold set.

8.5 Function to “Fix the density”

The density function allows to determine the density value of solid or liquid substances. The determination is based on the principle of Archimedes that a body immersed in a liquid receives an upward thrust equal to the weight of the volume of the displaced fluid. For the determination, you can use the lower weighing device (if present in the scale or the "hydrostatic weighing kit" to place on the weighing plate (optional).

To access the function from the "Functions" menu, tap the "**Density**" icon.

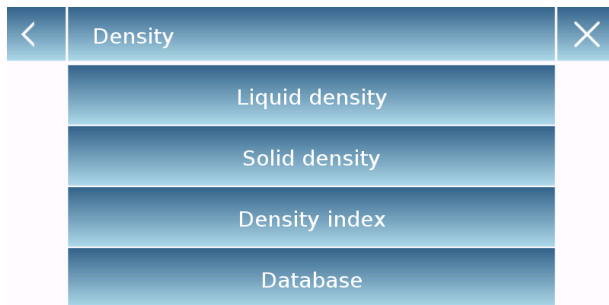

Select the mode:

Liquid density: selecting this type of measure, you will be required to enter the solid density value (g/cm³) to be used to determine the density of the liquid.

Then tap the "**Start**" button to proceed with the measurement

Solid density: selecting this type of measure, you will be required to enter the solid density value (g/cm³). If using distilled water or ethanol, select the relevant item below and enter only the liquid temperature value. The density of the selected liquid at the temperature entered will automatically be entered. (The reference tables are stored inside the device).

Then tap the "**Start**" button to proceed with the measurement

Density index: by selecting this type of measurement, you can determine the difference in density as a percentage between two solid samples. (One solidified at room temperature and the other under vacuum).

The density index can be determined by measuring for both samples their density value, or by using the "**theoretical density**" value for the sample solidified at room temperature and measuring the density value only for the vacuum sample. In this case, you need to tap the "**Theoretical density**" key to enter the value.

Then tap the "**Start**" button to proceed with the measurement

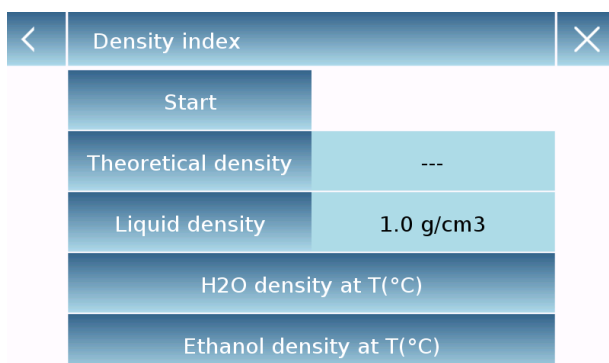
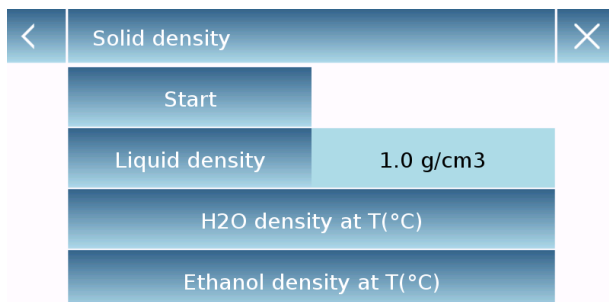

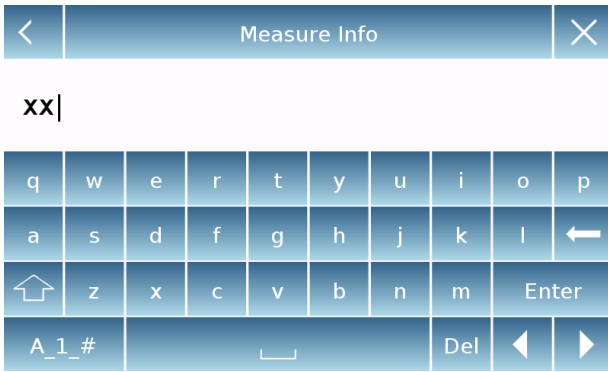

Optional information about the measurement to be performed will be required.

Tap the "**Enter**" key to confirm.

Now perform the steps shown on the display to determine the density index.

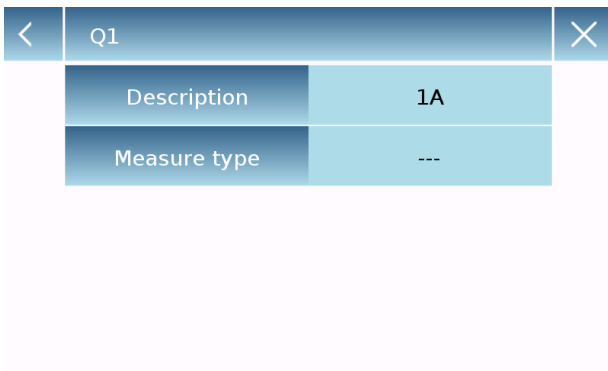

Database:

By tapping the "database" key, you can create a custom database to determine the different density types.

Tap the "**New**" key and enter the name of the new record to be stored.

- **Description:** enter a description of the item.
- **Measurement type:** Select the type of density to be determined.

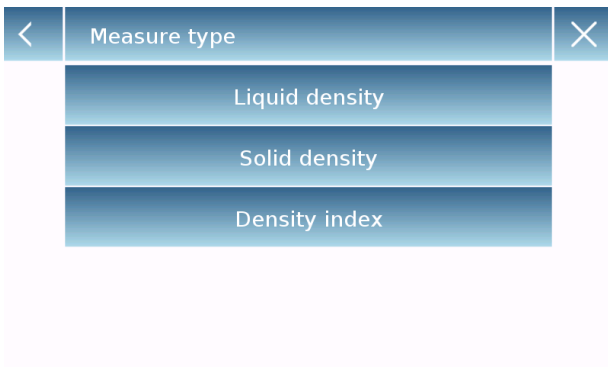

After entering all required data, tap the "**Save**" key to save the new record.

8.5.1 Screen with the “Density of a solid” calculation function.

Below are the functions for calculating the density of a solid.

Detected values for density determination

Solid density

1.4889 g/cm³

| | | |
|--------------------|---------------------|--|
| Q1 | | |
| A1 | | |
| Liquid density = | 1 g/cm ³ | |
| Weight in AIR = | 12.98 g | |
| Weight in LIQUID = | 4.26 g | |

Q1
A1

Esc Restart Print

Information about the database used:
Record name
Test description

Tap the "Esc" key to exit the function, the "Restart" key to make a new measurement, and the "Print" key to print the measurement result.

8.5.2 Screen with the “Density of a liquid” calculation function

Below are the functions for calculating the density of a liquid.

Detected values for density determination

Solid density

1.4889 g/cm³

| | | |
|--------------------|---------------------|--|
| Q1 | | |
| A1 | | |
| Sinker density = | 3 g/cm ³ | |
| Weight in AIR = | 12.82 g | |
| Weight in LIQUID = | 4.27 g | |

Q1
A1

Esc Restart Print

Information about the database used:
Record name
Test description

Tap the "Esc" key to exit the function, the "Restart" key to make a new measurement, and the "Print" key to print the measurement result.

8.5.3 Screen with the "Density index" calculation function.

Below are the functions for calculating the density index.

Detected values for density determination

The screenshot shows the 'Density index' calculation function interface. The main display area shows the result **-49.67%** with a progress bar below it. The top bar contains the text 'Density index' and a list icon. The bottom bar contains the text 'Q1', 'A1', and three buttons: 'Esc', 'Restart', and 'Print'. Two callout boxes provide additional data:

Callout 1 (top right):

```
Q1
A1

xx
Liquid density = 1 g/cm3

Theoretical density = 1 g/cm3
Density VACUUM = 1.4967 g/cm3
```

Callout 2 (middle right):

```
Q1
A1

Weight in AIR (VACUUM) = 12.87 g
Weight in LIQUID (VACUUM) = 4.27 g
```

Information about the database used:
Record name
Test description

Tap the "**Esc**" key to exit the function, the "**Restart**" key to make a new measurement, and the "**Print**" key to print the measurement result.

8.6 "Statistics" function

This function allows you to perform weighing statistics in simple mode, without defining the nominal weight and tolerance value, or, using database statistics, you can define the relative nominal weight and tolerance values. At the end of the procedures in both cases, it is possible to print the statistical result of the weights.

To access the function from the functions menu, tap the "**Statistics**" icon.

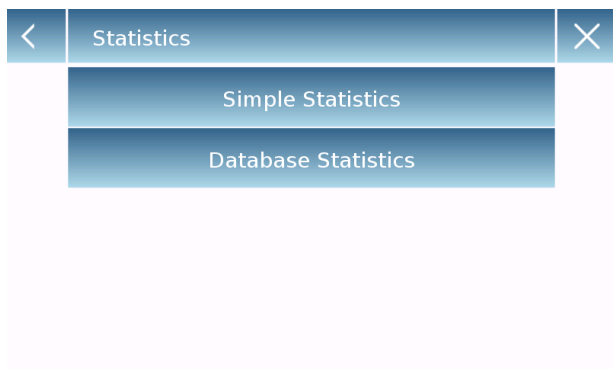

Select the mode:

Simple statistics: by selecting the simple function, you can perform the statistics up to 500 consecutive weights.

Tap the "Simple Statistics" button and immediately the screen will be activated to perform the weighing.

Database statistics: by selecting the statistical mode from the database, you can store and then recall a custom statistics method.

By tapping the "database" key, you can create a custom database to determine the different density types.

Tap the "**New**" key and enter the name of the new record to be stored.



- **Description:** enter a description of the item.
- **Nominal weight:** enter the nominal weight value and select the desired unit of measurement.
- Enter values for tolerance check (Optional Data).

- **T2+ :** 2nd positive tolerance
- **T2- :** 1st negative tolerance
- **T1+ :** 1st positive tolerance
- **T1- :** 1st negative tolerance

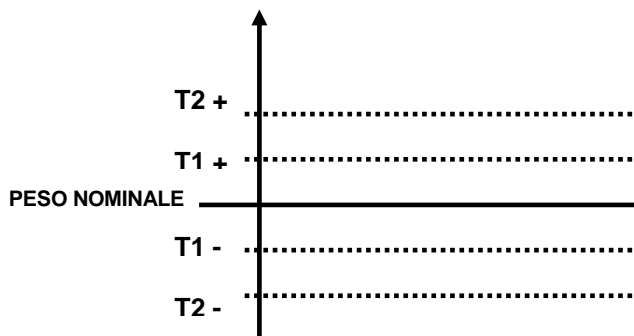

After entering all required data, tap the "**Save**" key to save the new record. Before performing the save, a congruity check of the entered data is performed. An error will be reported to make the necessary corrections and retouch the save key.

8.6.1 Screen with "Simple statistics" function

Below are the simple statistical function functions.

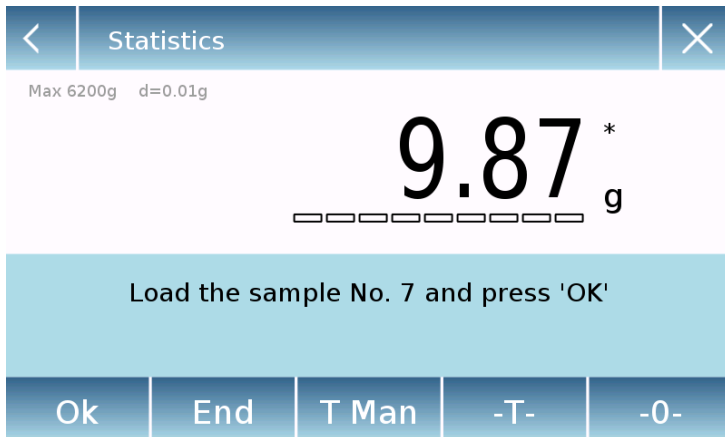

Tap the "Ok" key to capture a new weight.
 Tap the "T Man" key to enter a manual tare value
 Tap the "-T-" key to run a manual tare
 Touch the "- 0 " key to reset the plate.
 Tap the "End" key to end the weighing acquisition and follow the statistical calculation



The screenshot shows the "End" screen with a list of statistical data on the left and a list of captured values on the right. An arrow points from the text "List of the values captured" to a list icon on the right side of the screen.

| Statistical Data | | List of the values captured | | |
|-----------------------|---------|-----------------------------|-----|---------|
| Samples = | 6 | N. 001 | W = | 8.60 g |
| Minimum value = | 4.35 g | N. 002 | W = | 12.91 g |
| Maximum value = | 17.13 g | N. 003 | W = | 12.88 g |
| Difference = | 12.78 g | N. 004 | W = | 17.13 g |
| Sum = | 65.79 g | N. 005 | W = | 4.35 g |
| Average = | 10.96 g | N. 006 | W = | 9.92 g |
| Standard deviation = | 4.38 g | | | |
| Coeff. of variation = | 39.94 % | | | |

At the bottom of the screen, there are three buttons: "Esc", "Restart", and "Print".

Tap the "Esc" key to exit the function, the "Restart" key to make a new measurement and the "Print" key to print the measurement result.

8.6.2 Screen with “Database statistics” function

Below are the functions related to the database statistics function.

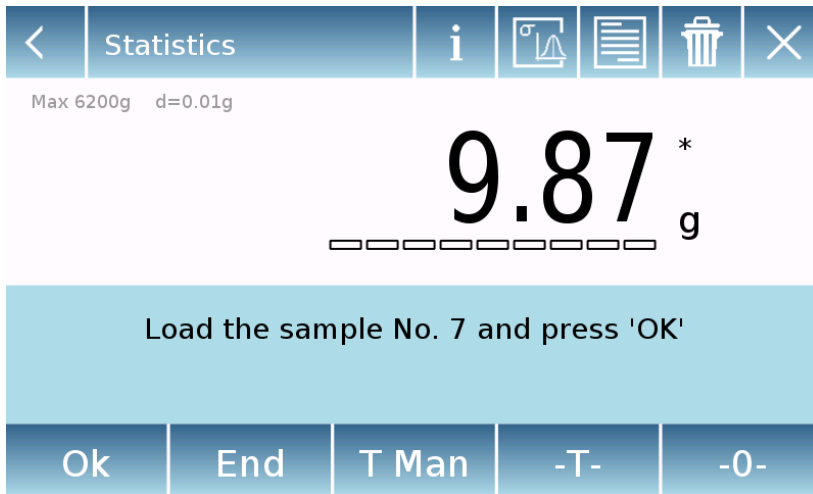

Tap the " **Ok**" key to capture a new weight.

Tap the " **T Man**" key to enter a manual tare value

Tap the " **-T-**" key to run a manual tare

Touch the " **- 0** " key to reset the plate.

Tap the " **End**" key to end the weighing acquisition and follow the statistical calculation

Tap the key  to delete the last weight captured.

Tap the key  to display the weights captured.

| | | |
|--------|-----|---------------|
| N. 001 | P = | 10.00 g |
| N. 002 | P = | 10.00 g |
| N. 003 | P = | 10.22 g > T2+ |
| N. 004 | P = | 8.35 g < T2- |
| N. 005 | P = | 9.59 g < T2- |

Tap the key  to display the parameters set for statistical calculation

A1

Nominal Weight = 10 g

T2+ = 2 %

T1+ = 1.5 %

T1- = 1.8 %

T2- = 1.9 %

Tap the key



to display the temporary statistical report..

< Report

| | |
|-----------------------|------------------|
| Samples = | 6 |
| Minimum value = | 9.84 g |
| Maximum value = | 17.15 g |
| Difference = | 7.31 g |
| Sum = | 73.73 g |
| Average = | 12.29 g |
| Standard deviation = | 2.98 g |
| Coeff. of variation = | 24.27 % |
| Out T2+: 3 50.0 % | Out T2-: 0 0.0 % |
| Out T1+: 0 0.0 % | Out T1-: 0 0.0 % |

Ok

After tapping the "End" key, the screen with the result of the weighing statistics is displayed.

End

| | |
|-----------------------|------------------|
| Samples = | 6 |
| Minimum value = | 9.84 g |
| Maximum value = | 17.15 g |
| Difference = | 7.31 g |
| Sum = | 73.73 g |
| Average = | 12.29 g |
| Standard deviation = | 2.98 g |
| Coeff. of variation = | 24.27 % |
| Out T2+: 3 50.0 % | Out T2-: 0 0.0 % |
| Out T1+: 0 0.0 % | Out T1-: 0 0.0 % |

Esc Restart Print

Tap the "Esc" key to exit the function, the "Restart" key to make a new measurement and the "Print" key to print the measurement result.

8.7 “Textile” function

This function determines the title of the yarns by weighing a known length bundle. Also, using the database function, you can also perform a weighing statistics.

To access the function from the "Functions" menu, tap the "**Textile**" icon.

| | |
|----------|------|
| Textile | |
| Start | |
| Length | 10 m |
| Units | Tex |
| Database | |

Length:

enter the value of the bundle length; the value can be expressed in meters or yards. To select the desired unit on the Length Input Screen, tap the "**Units**" key and make the selection.

| | |
|-------|--|
| Units | |
| Tex | |
| Td | |
| Nm | |
| Nc | |

Units:

select the unit with which you want to view the result. (Tex, Td, Nm, Nc). However, the selected unit can still be modified during weighing by tapping the symbol displayed to the left of the weight.

Start:

after entering the required data, tap the "**Start**" button to execute the "Textile" function.

| | |
|-------------|------|
| 01 | |
| Description | A1 |
| Length | 10 m |
| Units | Tex |
| Statistics | On |
| ... | |

Database:

by touching the "**database**" key, you can create a custom database for "Textile" weighing.

Using the database in addition to the simple "textile" weighing, you can perform the statistical check of the weights.

Tap the "**New**" key and enter the name of the new record to be stored.

- **Description:** enter a description of the item.
- **Length:** select the desired measurement unit and enter the length of the bundle.

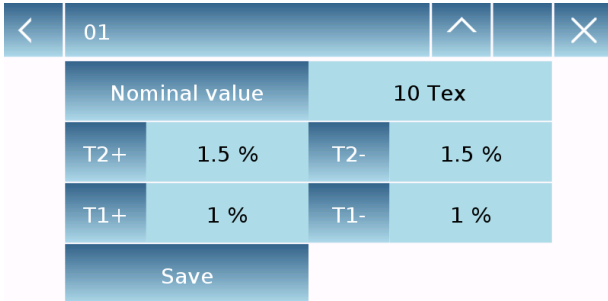

- **Unit:** select the unit with which you want to view the result. (Tex, Td, Nm, Nc). However, the selected unit can still be modified during weighing by tapping the symbol displayed to the left of the weight
- **Statistics:** you can activate the statistical check of the weights. Activating this function, you must enter the following data:
 - **Nominal value:** select the unit of measurement and enter the nominal weight value to be checked.
 - **T2+, T2-, T1+, T1-:** enter the error tolerance threshold values. (Optional entry).
 - **Save:** tap the "Save" button to save the entered record

8.7.1 Screen of the "Textile" function.

Below are the functions in the "Textile" screen.

Bundle length information and weight value in g

Exit the function



Measured unit selection key displayed

Tap the "Print" key to print the result.
 Tap the "T Man" key to enter a manual tare value
 Tap the "-T-" key to run a manual tare
 Touch the "- 0 -" key to reset the plate.

8.7.2 Screen of the database textile function with statistics enabled

Below are the functions related to the statistical database textile function.

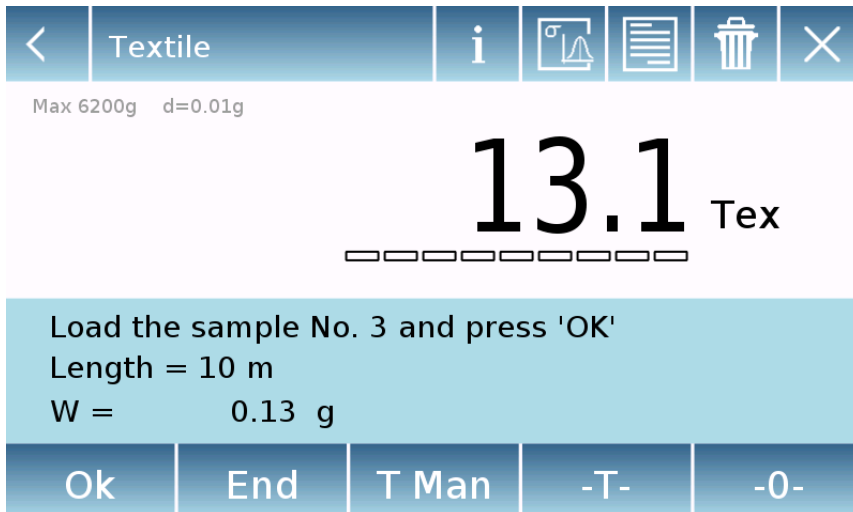

Tap the "**Ok**" key to acquire a new weight.

Tap the "**T Man**" key to enter a manual tare value

Tap the "**-T-**" key to run a manual tare

Touch the "**- 0 -**" key to reset the plate.

Tap the "**End**" key to end the weighing acquisition and follow the statistical calculation

Tap the key  to delete the last weight acquired.

Tap the key  to view the weights acquired

| | | |
|--------|-----|----------------|
| N. 001 | V = | 9.4 Tex < T2- |
| N. 002 | V = | 9.4 Tex < T2- |
| N. 003 | V = | 13.1 Tex > T2+ |
| N. 004 | V = | 13.1 Tex > T2+ |

Tap the key  to display the parameters set for statistical calculation

```

A1
Length = 10 m
Units = Tex
Statistics = 0n
Nominal value = 10 Tex
T2+ = 1.5 %
T1+ = 1 %
T1- = 1 %
T2- = 1.5 %
    
```

Tap the key



to display the temporary statistical report.

Report

| | |
|-----------------------|--------------------|
| Samples = | 3 |
| Minimum value = | 3.7 Tex |
| Maximum value = | 9.6 Tex |
| Difference = | 5.9 Tex |
| Sum = | 18.8 Tex |
| Average = | 6.3 Tex |
| Standard deviation = | 3.0 Tex |
| Coeff. of variation = | 48.25 % |
| Out T2+: 0 0.0 % | Out T2-: 3 100.0 % |
| Out T1+: 0 0.0 % | Out T1-: 0 0.0 % |

Ok

After tapping the "End" key, the screen with the result of the weighing statistics is displayed.

End

| | |
|-----------------------|--------------------|
| Samples = | 3 |
| Minimum value = | 3.7 Tex |
| Maximum value = | 9.6 Tex |
| Difference = | 5.9 Tex |
| Sum = | 18.8 Tex |
| Average = | 6.3 Tex |
| Standard deviation = | 3.0 Tex |
| Coeff. of variation = | 48.25 % |
| Out T2+: 0 0.0 % | Out T2-: 3 100.0 % |
| Out T1+: 0 0.0 % | Out T1-: 0 0.0 % |

Esc Restart Print

Tap the "Esc" key to exit the function, the "Restart" key to make a new measurement and the "Print" key to print the measurement result.

8.8 “Animal weighing” function

This function allows you to measure the weight of unstable samples (i.e. animals) or samples that are in very unstable environments. The weight is determined in the form of an average value based on multiple weight measurement cycles within the set time interval.

To access the function from the "Functions" menu, tap the "**Animal weighing**" icon.



Measurement time:

enter the express measurement time in seconds. (Minimum value 5 seconds, maximum 90 seconds)

Start:

after entering the required data, tap the "Start" button to perform the "Animal weighing" function.

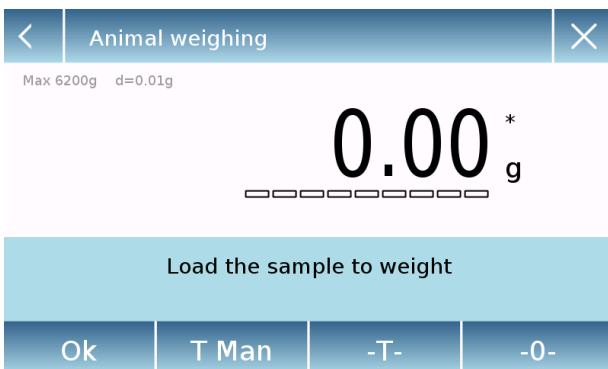

If necessary, reset the indication or load any tare.

Load the sample to be analyzed and tap the "**Ok**" key.

8.8.1 Screen of the "Animal weighing" function.

Below are the functions in the "Animal weighing" screen.

Information during weight capture

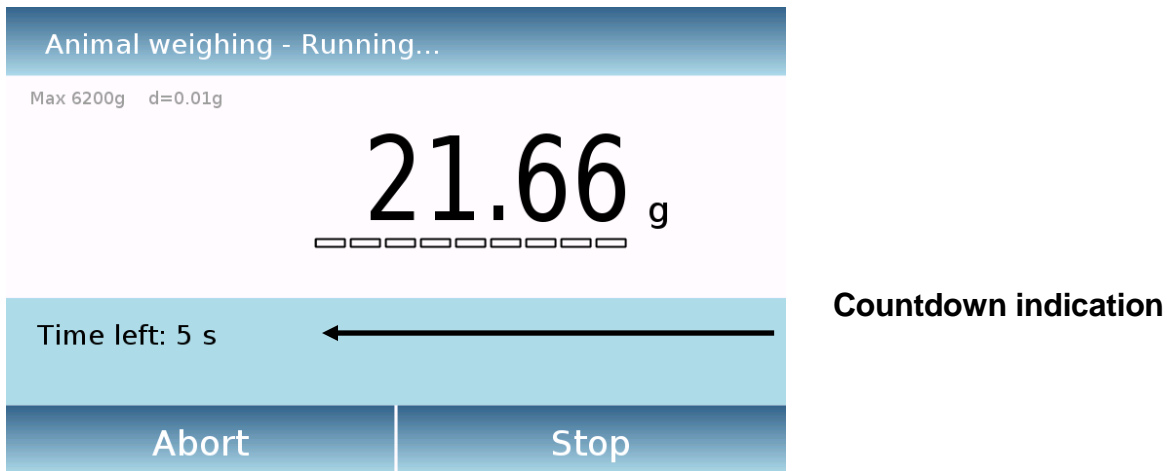

Tap the "**Abort**" button to cancel the measurement
Tap the "**Stop**" button to stop the countdown and display the result

Information at the end of weight capture

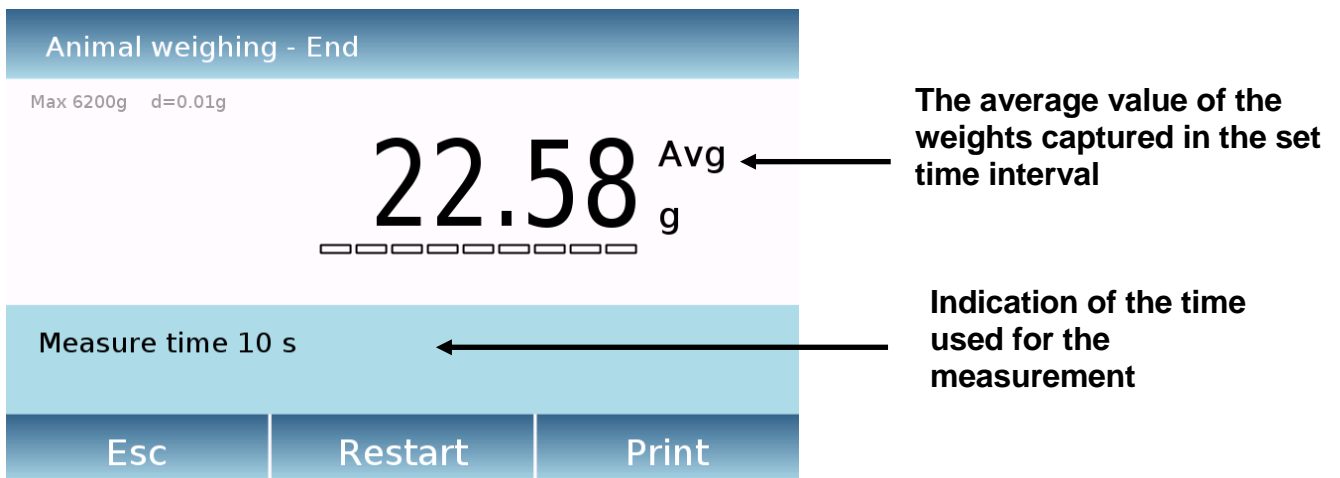

Tap the "**Esc**" key to exit the function, the "**Restart**" key to make a new measurement and the "**Print**" key to print the measurement result.

8.9 "Maximum load" function

This function allows to measure the maximum breakage load of a solid.

To access the function from the "Functions" menu, tap the "**Maximum load**" icon.

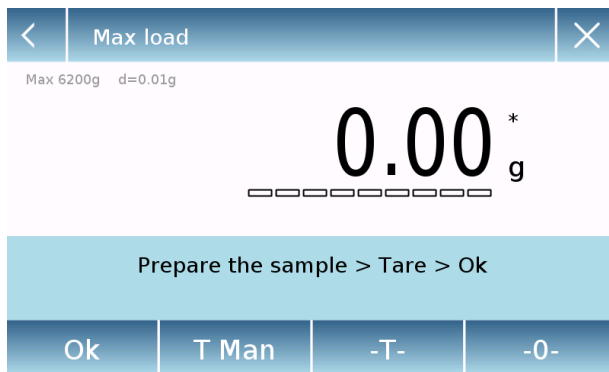

Selecting the function immediately displays the measurement screen.

- Prepare the sample to be tested on the weighing plate.
- Perform tare or zero reset if necessary.
- Tap the "**Ok**" key to start the test.



Once the tested sample breakage load is reached, the maximum weight will be displayed.

Weight detected on the plate

Tap the "**Esc**" key to exit the function, the "**Restart**" key to make a new measurement and the "**Print**" key to print the measurement result.

8.10 "Recipe" function

This function allows you to prepare a compound by dosing a set of components in manual mode "Simple recipe" or by calling a formula with ingredients and tolerances previously entered in the recipes database.

To access the function from the "Functions" menu, tap the "**Recipe**" icon.



Simple recipe :

this mode allows you to carry out a series of consecutive weights and finally get the total weight of the dosed components and the relative list with the value of the individual weights.

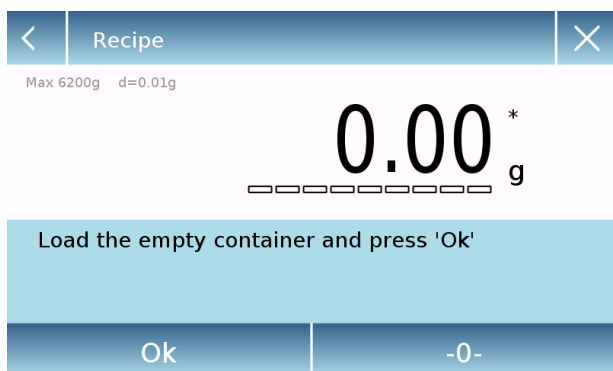

Tapping the "Simple recipe" button immediately displays the measurement screen.

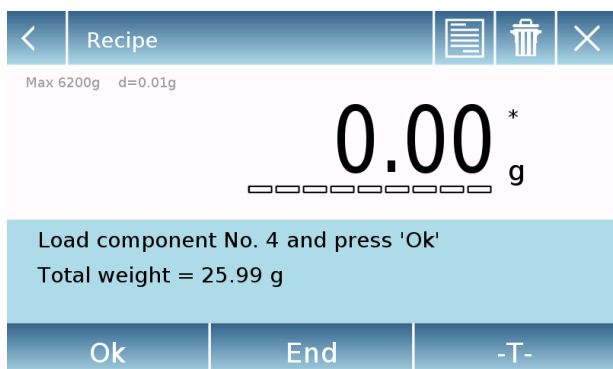

- Load any container and run the tare. Or, if necessary, reset the indication with the "0" key.
- Now dose the first component and tap the "Ok" key to confirm the capture.
- Then repeat the operation for all the components of the recipe.
- To finish the dosing operation of the components, tap the "End" key.

| | | | | | | | | | | | |
|-------|-----------|---|---|---|---|---|-----|-------|---|--|---|
| < | Record Id | | | | | | | | | | × |
| CR-1 | | | | | | | | | | | |
| - | = | % | 7 | 8 | 9 | + | * | : | : | | |
| # | (|) | 4 | 5 | 6 | - | / | , | ← | | |
| ⌂ | < | > | 1 | 2 | 3 | 0 | . | Enter | | | |
| A_1_# | | | | | | | Del | ← | → | | |

| | | | | | | | | | | | |
|-------------|------|--|----------|--|--|--|--|--|--|--|---|
| < | CR-1 | | | | | | | | | | × |
| Description | | | COLOR-35 | | | | | | | | |
| Add | | | Save | | | | | | | | |

| | | | | | | | | | | | |
|--------------|------|--|--------|--|--|--|--|--|--|--|---|
| < | CR-1 | | | | | | | | | | × |
| Name | | | COMP-1 | | | | | | | | |
| Quantity | | | 10 g | | | | | | | | |
| Toler. T+ | | | 2 % | | | | | | | | |
| Toler. T- | | | 1 % | | | | | | | | |
| Confirmation | | | | | | | | | | | |

| | | | | | | | | | | | |
|-------------|------|--|----------|--|--|--|--|--|--|--|---|
| < | CR-1 | | | | | | | | | | × |
| Description | | | COLOR-35 | | | | | | | | |
| COMP-1 | | | 10 g | | | | | | | | |
| Add | | | Save | | | | | | | | |

Database recipe:

By tapping the "**database**" key, you can create a custom database for the "recipe" function.

Using the database, you can store custom recipes with a set of components and their tolerances.

Tap the "**New**" key and enter the name of the new record to be stored.

- **Description:** enter the item description.
- **Add:** tap the add button to insert a component.

- **Name:** enter the name of the component.
- **Quantity:** select the desired unit of measurement and enter the nominal quantity of the component.
- **Toll T+:** enter positive percentage tolerance.
- **Toll T-:** enter negative percentage tolerance.
- **Confirmation:** tap the confirmation key to accept the entered values. Verification of the correctness of the data entered in case of error signal will be performed; check that all parameters entered are congruent.

After confirming, proceed with the "add" button to enter all the desired components.

- **Save:** after entering all the desired components, tap the "Save" button to store the recipe.

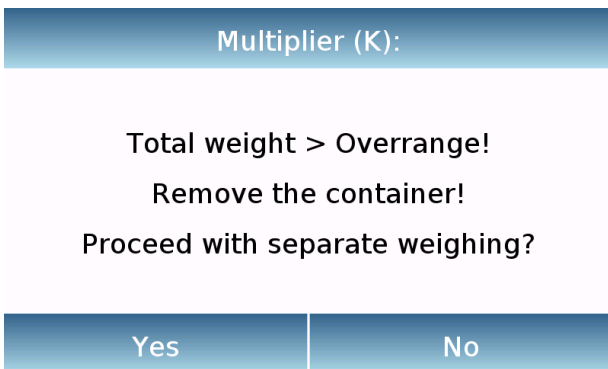
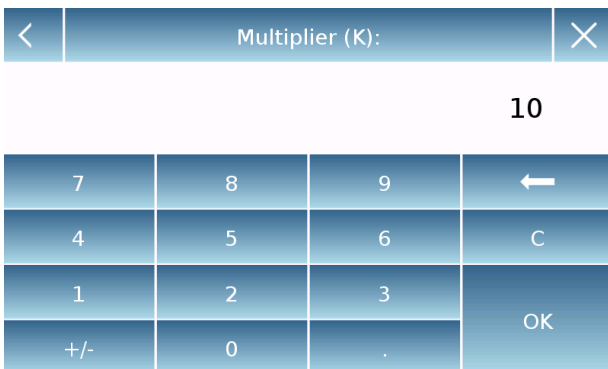
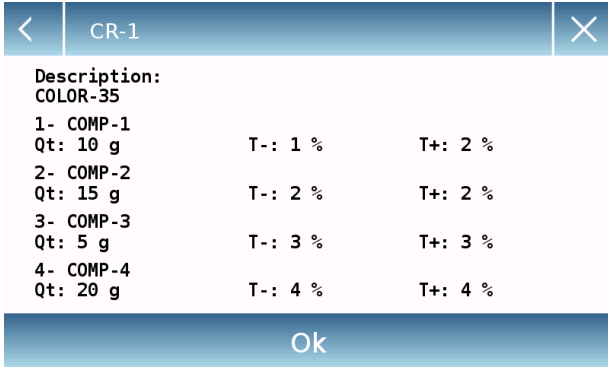
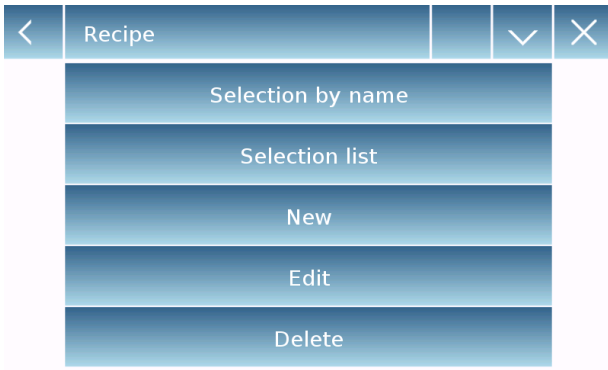

To recall the recipe entered in the database, use the **"Select From List"** command, select the recipe you want and proceed as shown below.

After selecting the desired recipe, a summary screen will be displayed showing all the components and their amount needed to make the recipe.

Tap the **"Ok"** key to confirm and proceed by entering the multiplication factor needed to determine the total amount of the recipe. (i.e. if the recipe has been stored to produce 10g of product and you want to produce 100g insert a "K" factor of 10). If the entered value does not allow the dosing of one of the components because its quantity exceeds the scale capacity, it will not be accepted.

If the total weight of the recipe instead exceeds the scale capacity, but the individual components are lower, it will be asked whether to proceed with the "separate recipe".

- **Yes:** to proceed with the separate recipe.
- **No:** to change the value of the multiplier factor "K" and reduce the quantities.

The recipe screen shows the type of recipe you are using by displaying two symbols as described below:

Symbol displayed in case of **"unique recipe"**.

Symbol displayed in case of **"separate recipe"**.

8.10.1 Screen of the "Simple recipe" function.

The following are the functions for the simple recipe function.

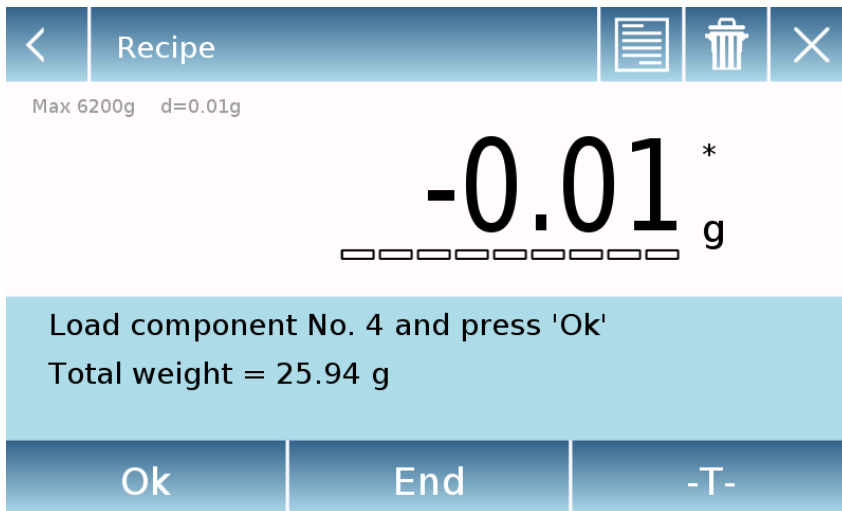

Tap the "Ok" key to acquire a new weight.

Tap the "End" key to end the weighing capture and follow the statistical calculation

Tap the  key to clear the last weight acquired.

Tap the  key to view the weight acquired.

| | | |
|--------------|--------|---------|
| Comp. No. 01 | Q.ty = | 12.93 g |
| Comp. No. 02 | Q.ty = | 4.30 g |
| Comp. No. 03 | Q.ty = | 8.71 g |

After tapping the "End" key, the screen appears with the result of the sum of the weights.



Tap the "Esc" key to exit the function, the "Restart" key to make a new measurement and the "Print" key to print the measurement result.

8.10.2 Screen of the “Database recipe” function.

Below are the features in the "Database recipe" screen.

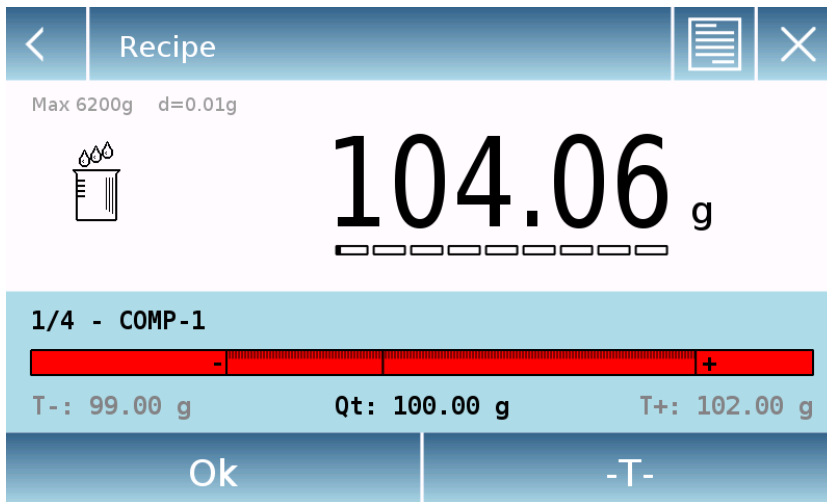

Tap the "Ok" key to acquire a new weight.
Tap the "T" key to reset the weight indication.

Tap the  key to view the list of the recipe components and the components already entered:



Dosing bar:



The dosing bar works with automatic graduated enlargement. When the dosed quantity approaches the two levels of tolerance, the center zone is automatically enlarged to allow dosing with a greater sensitivity.

The bar takes on different colors:

Yellow when the loaded weight is lower than the minimum threshold

Green when the weight is within the set range

Red when the weight is higher than the upper threshold set

If during dosing the amount of dosed component exceeds that allowed by the tolerances, it will be required to perform automatic adjustment of the recipe with a new total quantity and the quantity update of all the components of the recipe.



Tap the "Yes" button to confirm the adjustment, press the "No" button to return to the dosing screen. In this case, you can remove excess quantity or cancel the recipe by tapping the "X" key.

When the correct dosage of all components is completed, the actual dosed amount will be displayed:

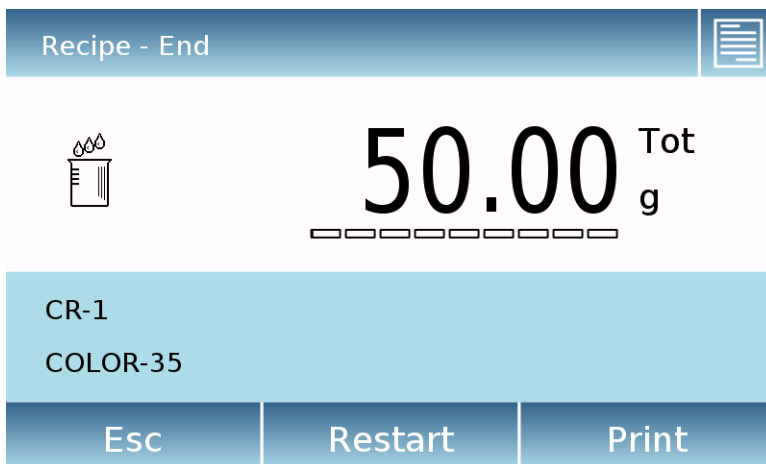

Tap the  to view the complete list of components and their dosed quantities.

Tap the "**Esc**" key to exit the function, the "**Restart**" key to make a new measurement and the "**Print**" key to print the measurement result.

8.11 Setting the GLP data

This function allows you to customize and create a database with G.l.p. parameters.

To access the function from the "Functions" menu, tap the "**GLP**" icon.



GLP Setup: use this command to enter GLP parameters when you do not want to save them to the database.

The data entry screen will be displayed. Tap the corresponding parameter to enter the desired data.

A screenshot of the 'GLP Setup' data entry screen. The header bar is identical to the previous screenshot. Below the header, there are three rows of input fields, each with a label on the left and a text input field on the right: 'ID Balance: int', 'ID Project: test', and 'ID User: default'. At the bottom left, there is a blue 'Ok' button.

- **Scale ID**
- **Project ID**
- **User ID**

After entering the data, press the "Ok" key to confirm.

Note that the maximum number of characters allowed per parameter is 20.

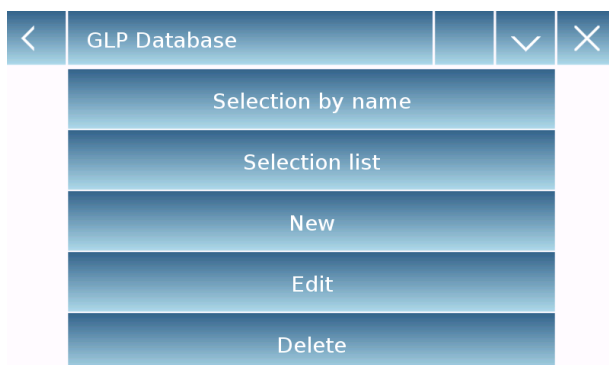

GLP Database: by tapping this command, you can access the GLP parameter database management menu

Below are all the available functions

- **Selection by name:** by tapping this key, you can call up a program by entering the corresponding name.
- **Selection list:** by tapping this button, you can call up a program by selecting it from a list.
- **New:** by tapping this button, you can enter a new record.
- **Edit:** by tapping this button, you can access the GLP parameters that can be changed.
- **Delete:** tap this button to delete one or more previously stored records.
- **Print:** by tapping this button you can select a GLP record and print it.
- **Export (Usb):** by tapping this button, you can export the database to the USB stick.



- **Import (Usb):** by tapping this key, you can import from a USB stick a predefined database previously

The selection, edit, delete, print, export and import commands are the same as described in **chapter 9.7.1**

New: this command allows you to enter a new record.

Enter the name you want to assign to the record and confirm with the "**Enter**" key.

The data entry screen will be displayed. Tap the corresponding parameter to enter the desired data.

- **Scale ID**
- **Project ID**
- **User ID**

After entering the data, press the "**Save**" key to confirm.

In order to save data, at least one of the three fields must be filled in, otherwise an incomplete data screen will be displayed.

After entering the record to select it, use the "Select from list" or "Select by name" command.

Tap the desired record and confirm with the "**Ok**" key.

N.B. By entering the "**GLP**" command in the print setup menu or in the save file, the data set in the "**Balance id, Project id, User id**" fields will be reported.

9 Technical features

The Accuris Tx Analytical models are all intended for indoor use. Maximum installation altitude: 4000m; Degree of Pollution: 2; Overvoltage category: II

| | |
|---|--|
| Power supply unit supplied: | INPUT: Switching 100-240Vac~ 50/ 60Hz, OUTPUT: 24V DC 550mA, Potenza Max absorbed power 13.2VA |
| Adaptation to environmental conditions: | Selectable filters |
| Autozero: | Selectable from menu |
| Serial output: | RS232C |
| Working temperature: | +5°C - +35°C |

10 Warranty

- The warranty period is 24 months from the date of purchase as per the customer's printed purchase order or sales order record from their distributor.
- The warranty covers all parts that may have a manufacturing defect. It does not cover damaged mechanical and electronic parts due to improper installation, tampering, or improper use.
- The warranty does not cover damage caused by shocks, fall of the balance or fall of objects on the weighing plate.
- The transport to and from the Service Center is the responsibility of the customer.

11 Disposal



If the packaging is no longer used, it can be delivered to the local waste disposal center. The packaging is made entirely of non-polluting materials, recyclable as valuable secondary raw materials. Discharged batteries should not be disposed of in normal domestic waste. Drop them into the appropriate collection containers. In case of scrapping of the device, call the local authorities. Remove the batteries before scrapping the unit.